

moldingknives.com

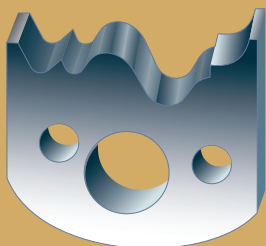

14TH edition
PROFILE & ACCESSORIES
CATALOGUE



**We manufacture molder knives,
shaper blades, and more!**

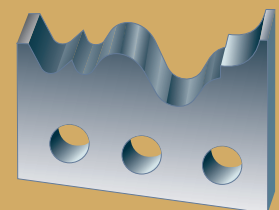

Contents

ASTRAGAL	4
BACK KNIVES	5
BAR RAIL.....	7
BASE CAPS.....	8
BASE MOLDINGS	9
BATTENS.....	11
BASE SHOES	11
BEADBOARD	12
BEDS.....	13
BULLNOSE	14
CASINGS.....	16
CASINGS (COLONIAL).....	22
CHAIR RAILS	23
COVES	24
CROWN MOLDING.....	25
DECKING.....	30
DOOR STOPS.....	31
DOWELLING / HALF ROUNDS	32
HAND RAIL	33
LOG SIDING	34
MITRED DOORS	36
PANEL STRIPS / MULLION CASINGS	38
PICTURE FRAMES	39
PICTURE MOLDINGS	40
PLANTATION LOUVERS / SHUTTERS.....	41
PLINTH MOLDING	43
QUARTER ROUNDS	44
SHELF EDGE / SCREEN MOLD	45
TONGUE AND GROOVE.....	46
V's	50
WAINSCOTTING	51
WOOD PLANK PANELLING	52
MISCELLANEOUS	54
PICTURE GLOSSARY	57
ACCESSORIES.....	59

***Current pricing and more items
available online.***

www.moldingknives.com

Dear Woodworker,

Thank you for the opportunity to show you a selection of the products that we manufacture.

In addition to the enclosed popular stock profiles, we can manufacture and supply custom knives in as little as 24 hours.

Over the past 30 years we have designed tooling solutions for many interesting and challenging jobs. With over 100,000 custom knives made, use our experience to help make your next job efficient and profitable. Fast turn-around, competitive prices, and top quality have all come together to give us the privilege of earning the trust of thousands of woodworkers.

We are a family owned small business that takes pride in the products that we make and sell. Efforts to reduce our environmental footprint are ongoing: Our EDM machines manufacture knives without producing metal waste. All offcuts and machining particles are captured and recycled. We sort and recycle all office and shop supplies. The heat generated from our machines is captured and coupled with a wood pellet heating unit that helps heat our shop in the winter time.

We take pride in helping our customers find the optimal tooling solution. After all, when our customers are profitable, so are we.

14th EDITION PROFILE CATALOGUE

PUBLISHER:

moldingknives.com

EDITOR:

Fred Blois

ASSISTANT EDITOR

Craig Blois

LAYOUT/ARTWORK

Glenn MacKenzie

moldingknives.com

C/O: Woodmaster Tools of Canada

1176 Black Rock Road

Clifton, Nova Scotia B6L 1C1

Internet: <http://www.moldingknives.com>

Copyright ©2019

No part of this publication may be reproduced or transmitted in any form or by any means without the written permission of moldingknives.com.

ASTRAGAL

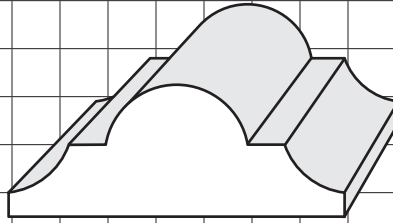

WM133

11/16" X 1-3/4"

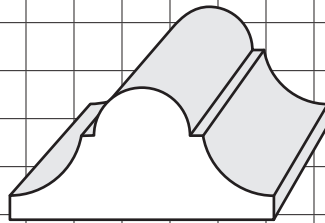

WM134

11/16" X 1-3/8"

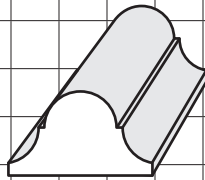

WM135

7/16" X 3/4"

BACK KNIVES

CK370 X 1.5"
0.08" DEEP X 1.5" WIDE

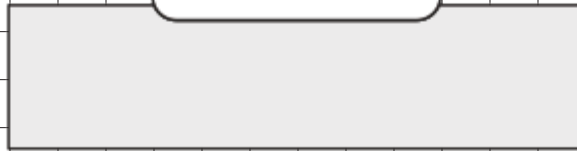

CK370 X 2.0"
0.08" DEEP X 2.0" WIDE

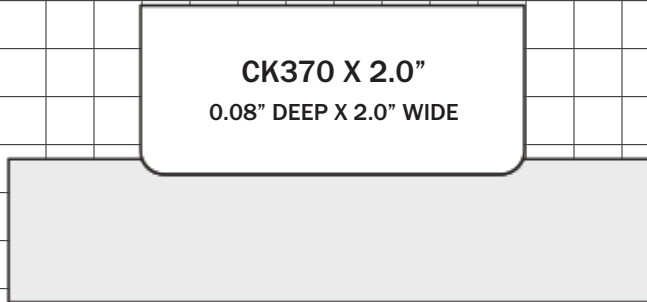

CK370 X 3.0"
0.08" DEEP X 3.0" WIDE

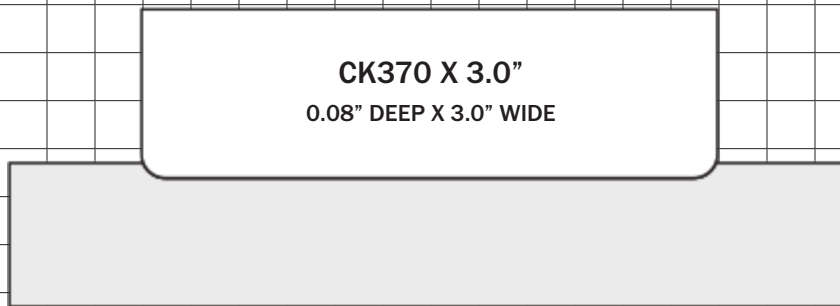

Various widths available.

BACK KNIVES

MK-0645

0.08" DEEP X 1.5" WIDE

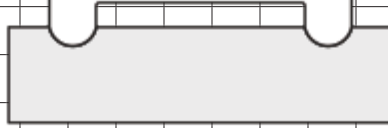

MK-0654

0.08" DEEP X 2.0" WIDE

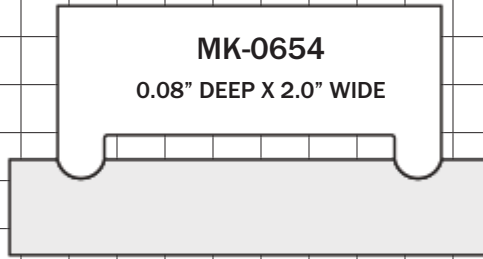

MK-0663

0.08" DEEP X 3.0" WIDE

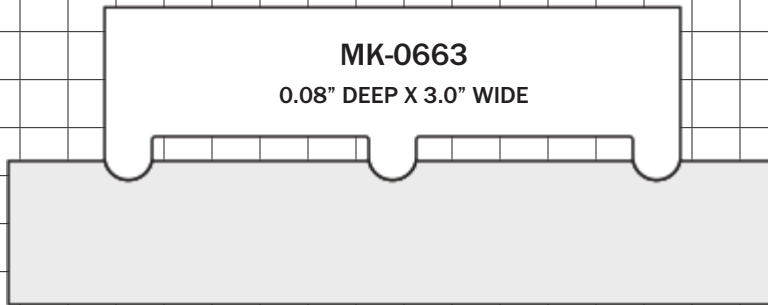

Various widths and bead configurations are available.

BAR RAIL

A set of three top and three back knives are required to produce the WM-4000.

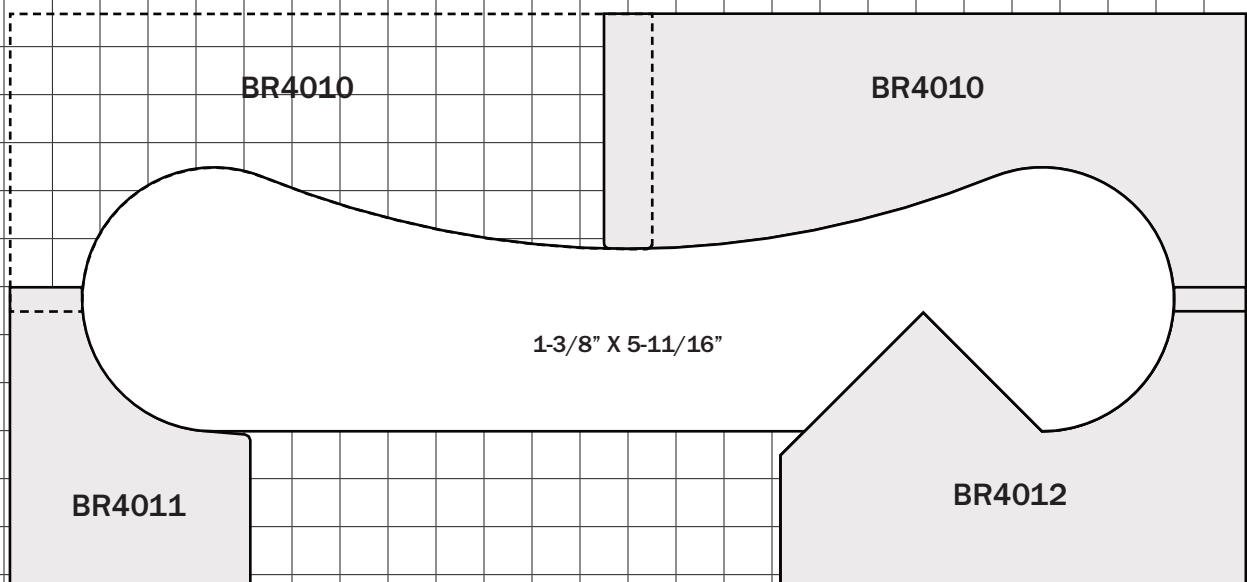
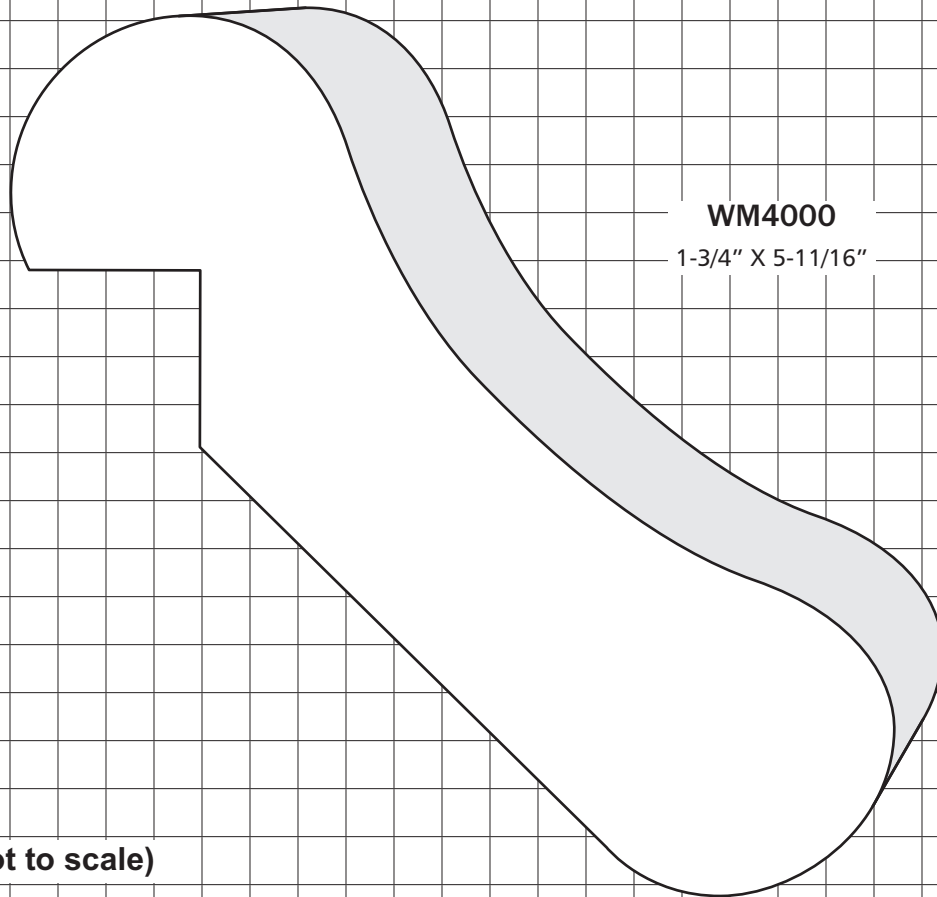

BASE CAPS

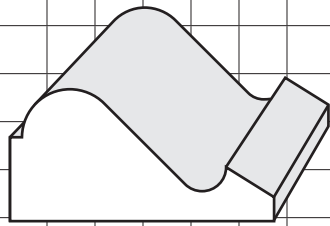

WM163

11/16" X 1-3/8"

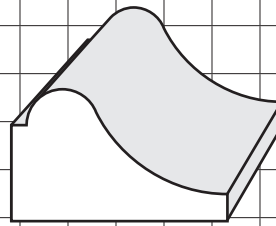

WM167

11/16" X 1-1/8"

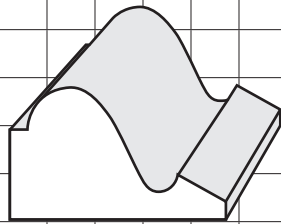

WM164

11/16" X 1-1/8"

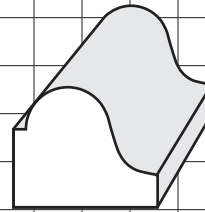

WM172

5/8" X 3/4"

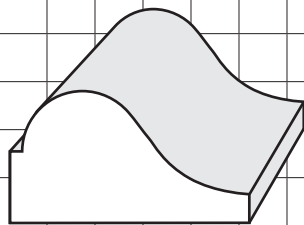

WM166

11/16 X 1-1/4"

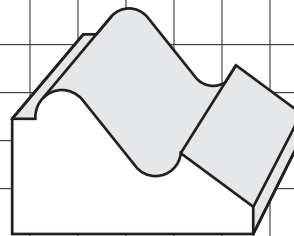

MK0043

3/4" X 1-1/4"

BASE MOLDINGS

Baseboard knives are most often bought in the open-end version.

See the picture glossary on page 57 to view an example.

Various widths of full-width knives are available.

These moldings require a back relief knife.

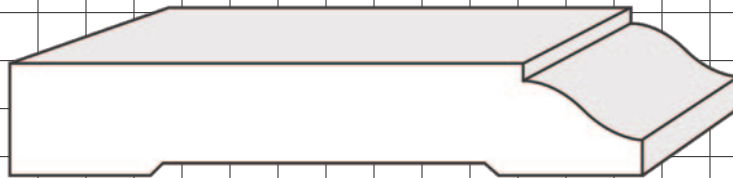

WM623 9/16" X 3-1/4"

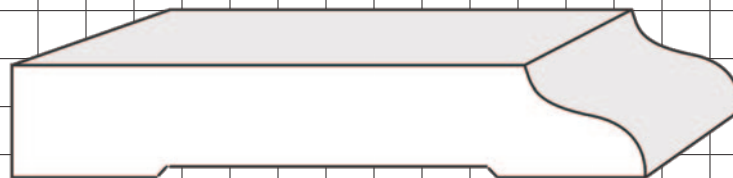

WM663 9/16" X 3-1/4"

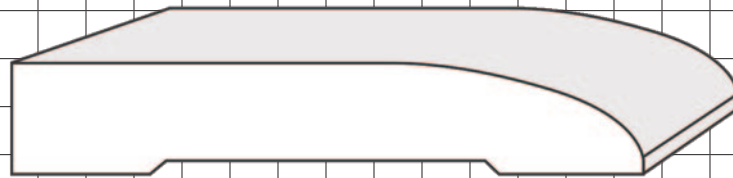

WM713 9/16" X 3-1/4"

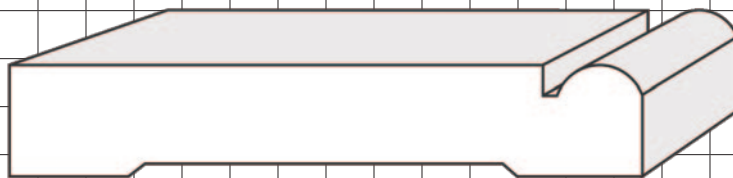

WM753 9/16" X 3-1/4"

BASE MOLDINGS

Baseboard knives are most often bought in the open-end version.

See the picture glossary on page 57 to view an example.

These moldings require a back relief knife.

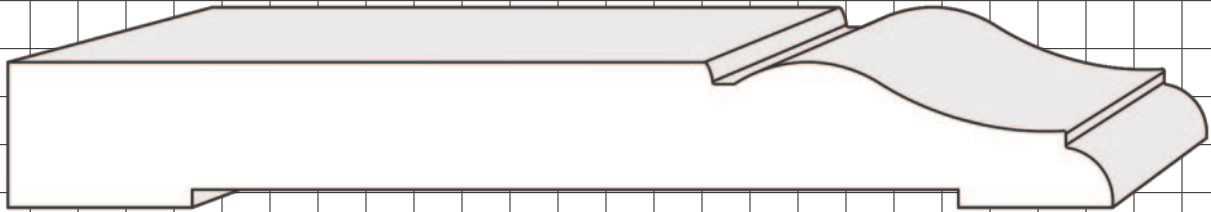

A11

3/4" X 5-3/4"

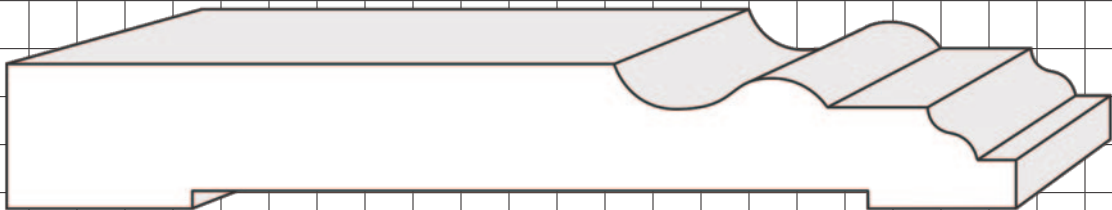

A12

3/4" X 5-1/4"

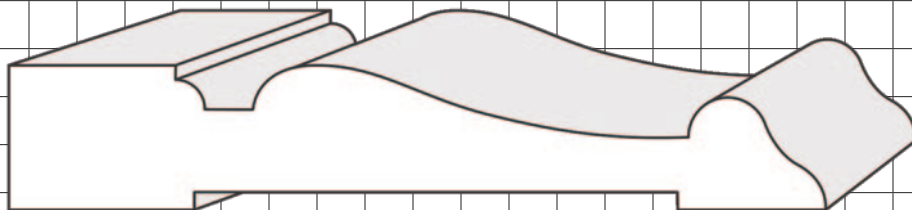

A16

3/4" X 4-1/4"

BASE SHOES

Recommend using 2-up knife to produce these moldings.
See the picture glossary on page 58 to view a 2-Up style knife.

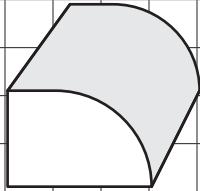

WM126
3/4" X 1/2"

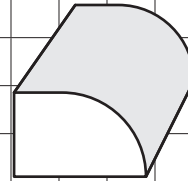

WM129
11/16" X 7/16"

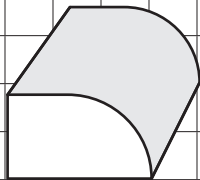

WM127
3/4" X 7/16"

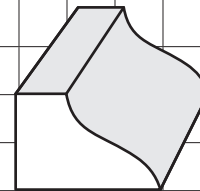

WM131
3/4" X 1/2"

BATTENS

These moldings require a back relief knife.

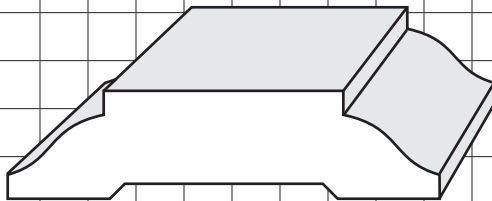

WM224
9/16" X 2-1/4"

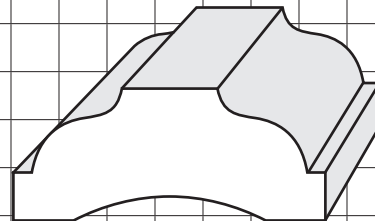

WM229
11/16" X 1-5/8"

BEADBOARD

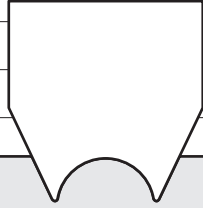

MK0060
1/2" Dia.

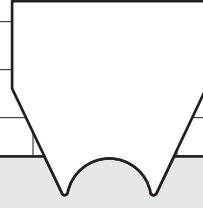

MK0061
7/16" Dia.

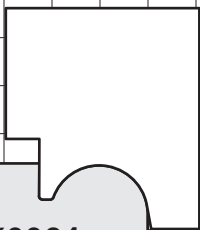

MK0064
1/2" Dia.

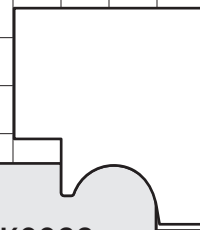

MK0066
7/16" Dia.

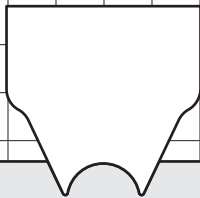

MK0062
3/8" Dia.

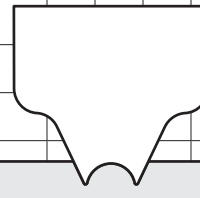

MK0063
1/4" Dia.

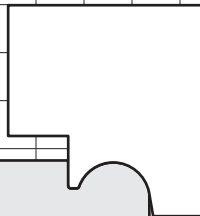

MK0068
3/8" Dia.

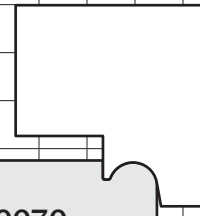

MK0070
1/4" Dia.

BEDS

These moldings require both a top and back knife to make the whole profile.

See the picture glossary on page 57 to view a Back Knife.

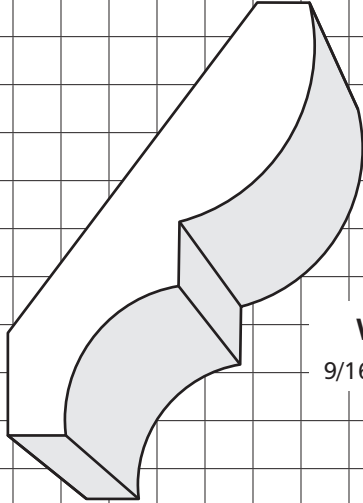

WM70

9/16" X 2-3/4"

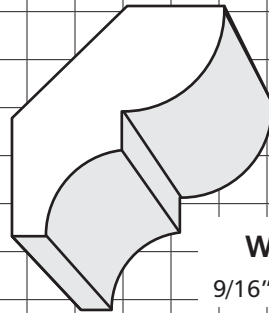

WM75

9/16" X 1-5/8"

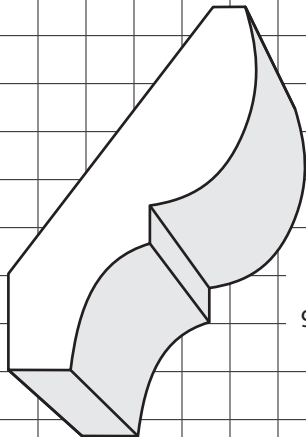

WM72

9/16" X 2-1/4"

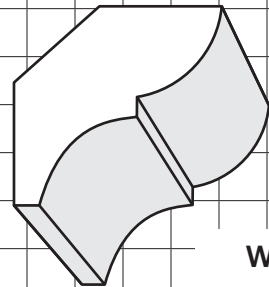

WM76

9/16" X 1-1/2"

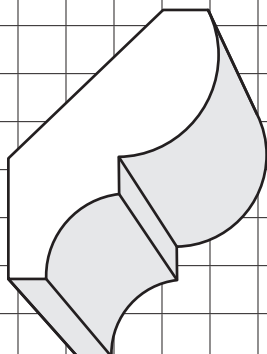

WM74

9/16 X 1-3/4"

BULLNOSE

These knives are offered as a half-knife to be run as shown or a full knife which requires the stock to be run on its edge. See the picture glossary on page 58 to view a Half-Knife example.

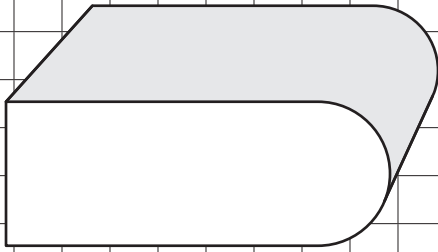

WM5004

3/4"

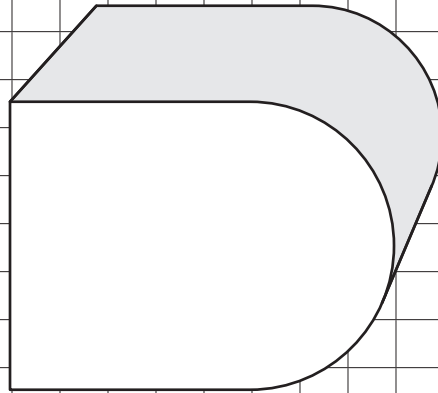

WM5006

1-1/2"

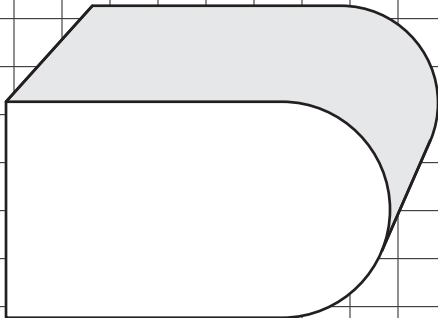

WM5005

1-1/8"

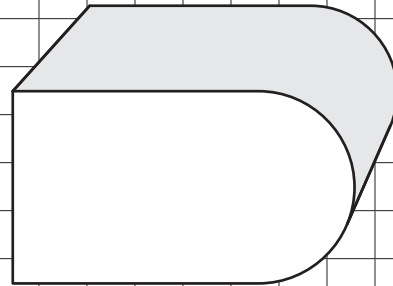

WM5007

1"

BULLNOSE

These knives are offered as a half-knife to be run as shown or a full knife which requires the stock to be run on its edge. See the picture glossary on page 58 to view a Half-Knife example.

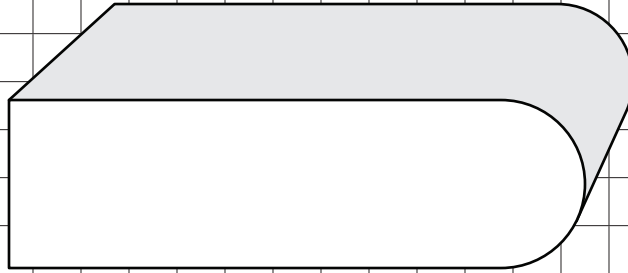

WM5008

7/8"

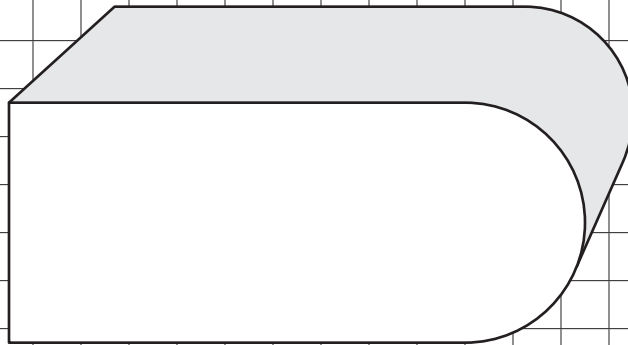

WM5009

1-1/4"

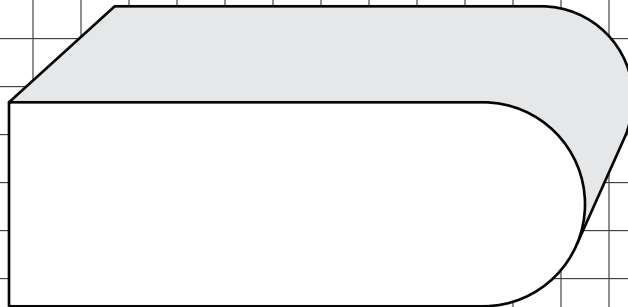

WM5010

1-1/16"

CASINGS

These moldings require a back relief knife (see pages 5-6).
Many of our casing knives are available as open-ended or plunge knives.
(See the picture glossary on pages 57-58 for examples).

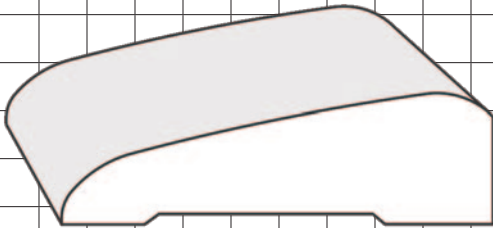

WM306

11/16" X 2-1/4"

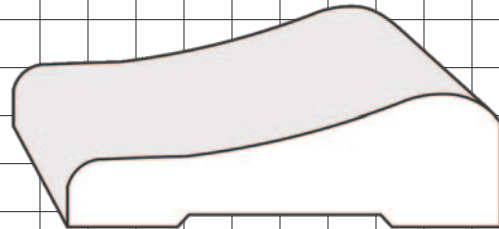

WM321

11/16" X 2-1/4"

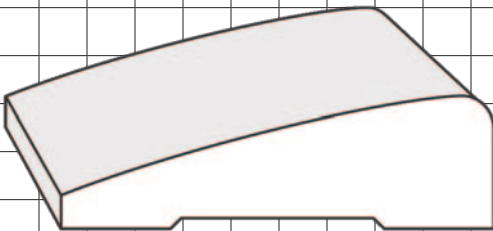

WM316

11/16" X 2-1/4"

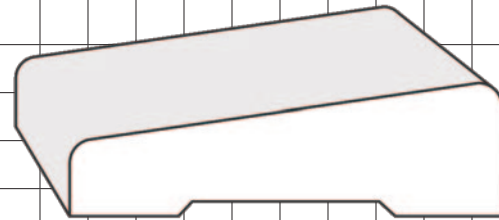

WM324

11/16" X 2-1/4"

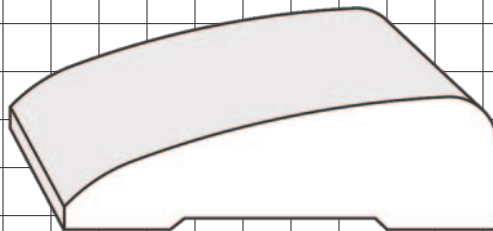

WM330

11/16" X 2-1/4"

CASINGS

These moldings require a back relief knife (see pages 5-6).
Many of our casing knives are available as open-ended or plunge knives.
(See the picture glossary on pages 57-58 for examples).

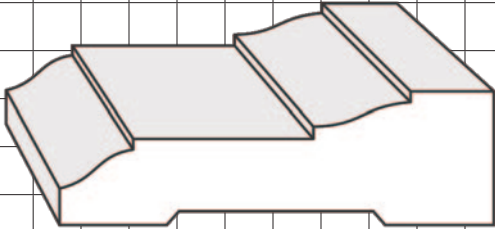

WM332
11/16" X 2-1/4"

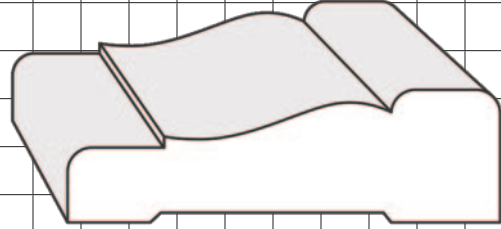

WM356
11/16" X 2-1/4"

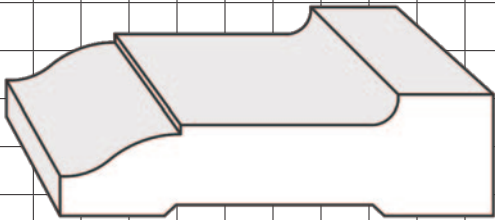

WM346
5/8" X 2-1/4"

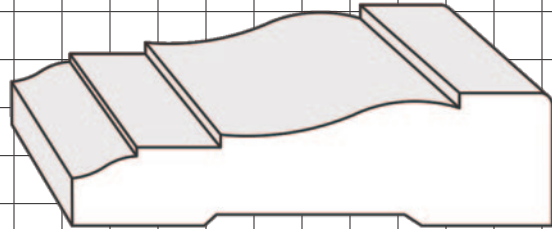

WM361
11/16" X 2-1/2"

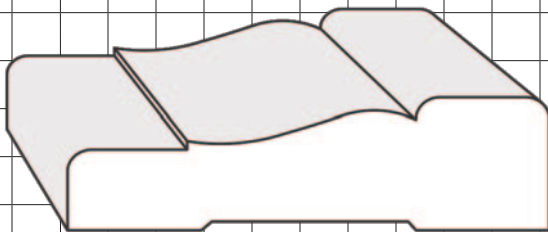

WM351
11/16" X 2-1/2"

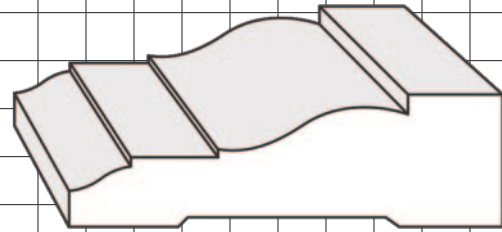

WM366
11/16" X 2-1/4"

CASINGS

— These moldings require a back relief knife (see pages 5-6).
— Many of our casing knives are available as open-ended or plunge knives.
— (See the picture glossary on pages 57-58 for examples).

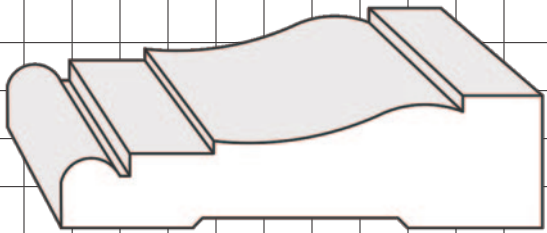

WM371
11/16" X 2-1/2"

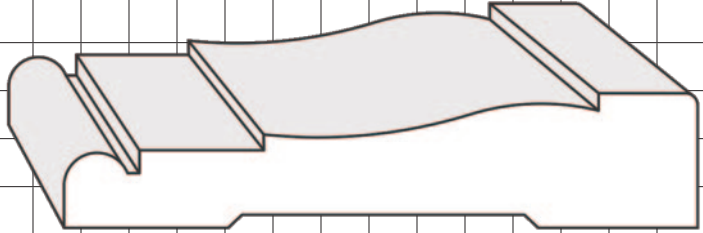

WM445
11/16" X 3-1/4"

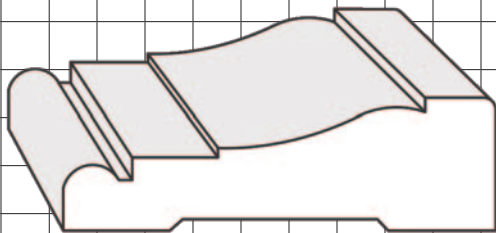

WM376
11/16" X 2-1/4"

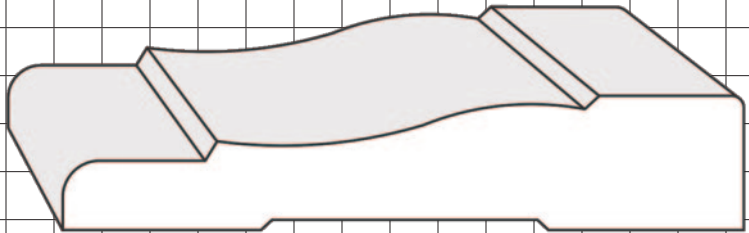

WM444
11/16" X 3-1/2"

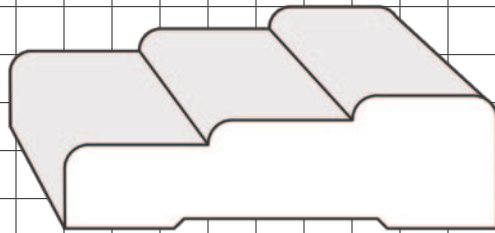

WM387
11/16" X 2-1/4"

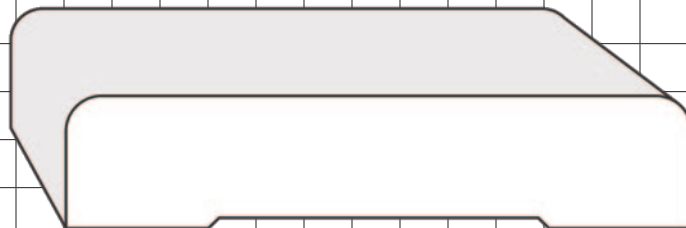

WM413
11/16" X 3-1/4"

This profile available in various widths.

CASINGS

These moldings require a back relief knife (see pages 5-6).
Many of our casing knives are available as open-ended or plunge knives.
(See the picture glossary on pages 57-58 for examples).

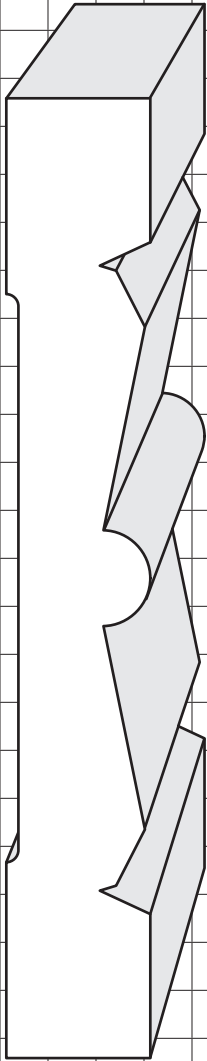

WM2003
3/4" X 5"

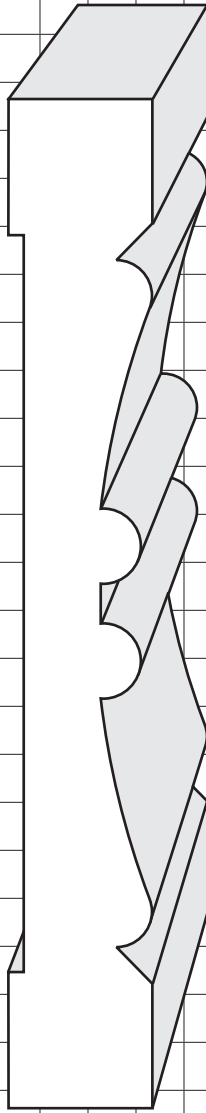

A44
3/4" X 5-1/4"

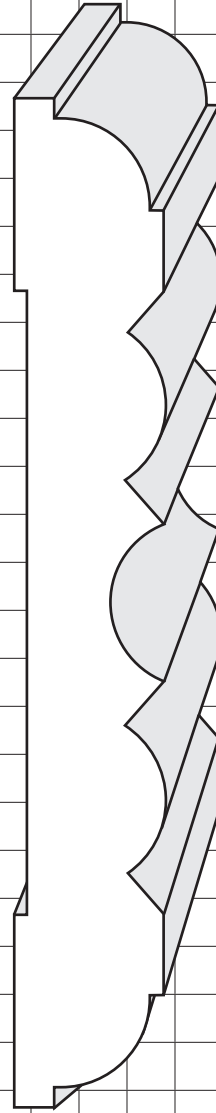

A45
3/4" X 5-1/4"

CASINGS

These moldings require a back relief knife (see pages 5-6).
Many of our casing knives are available as open-ended or plunge knives.
(See the picture glossary on pages 57-58 for examples).

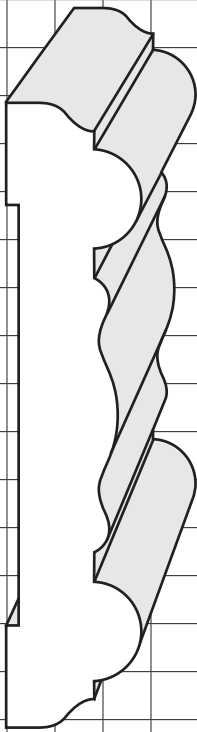

A41

3/4" X 3-1/4"

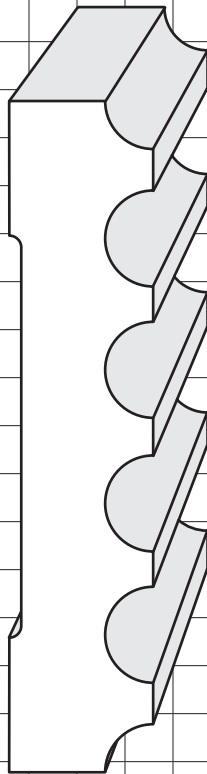

WM2004

3/4" X 3-1/2"

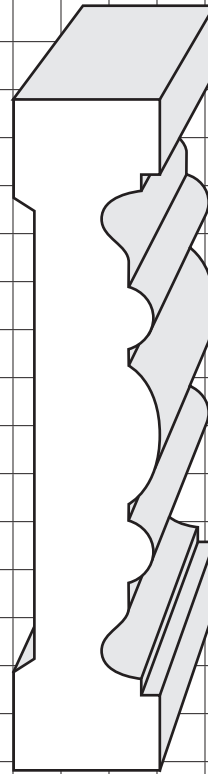

WM2006

3/4" X 3-1/2"

CASINGS

These moldings require a back relief knife (see pages 5-6).
Many of our casing knives are available as open-ended or plunge knives.
(See the picture glossary on pages 57-58 for examples).

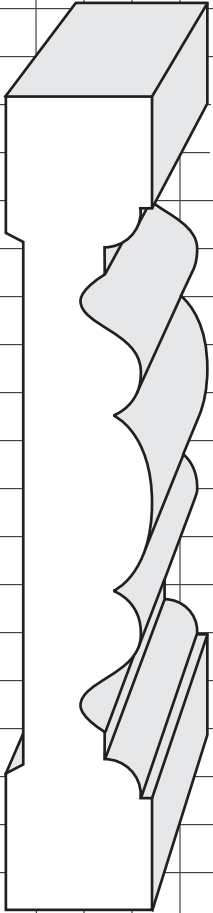

WM2008
3/4" X 4-1/4"

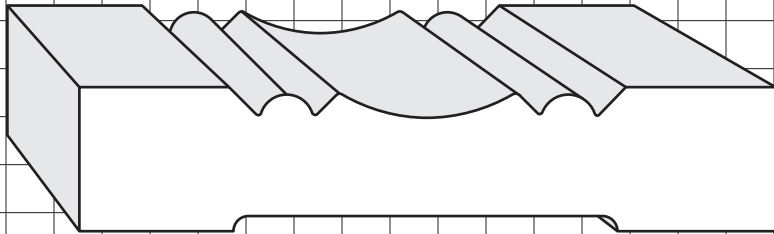

WM2010
3/4" X 3-5/8"

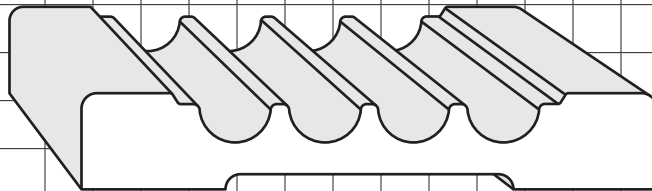

WM2011
1/2" X 3"

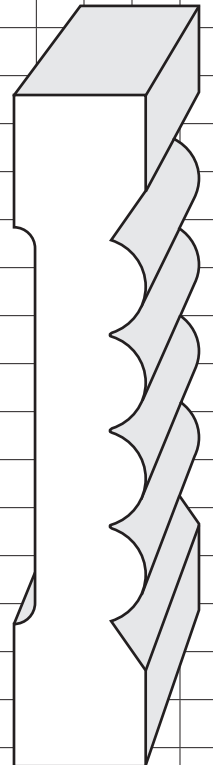

WM2009
11/16" X 3-1/2"

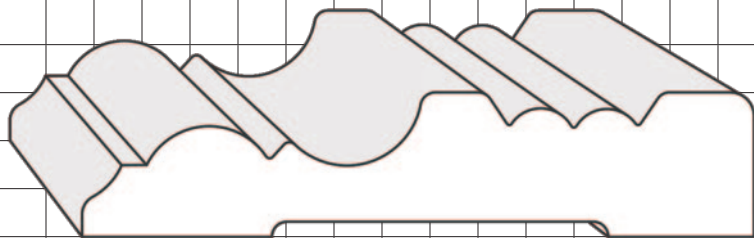

WM2012
3/4" X 3-1/2"

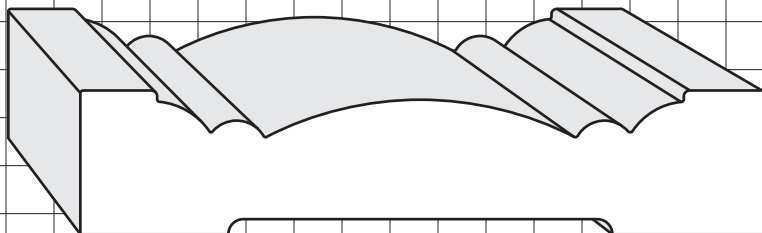

WM2013
3/4" X 3-9/16"

CASINGS (COLONIAL)

These moldings require a back relief knife (see pages 5-6).
Many of our casing knives are available as open-ended or plunge knives.
(See the picture glossary on pages 57-58 for examples).

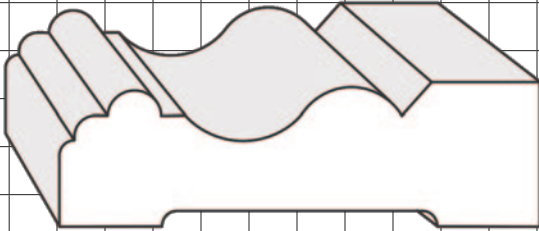

WM501
3/4" X 2-1/2"

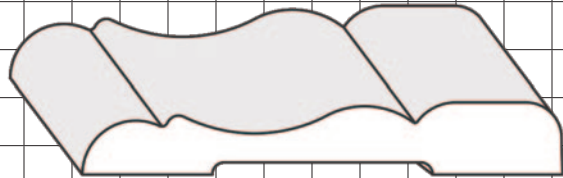

WM509
3/8" X 2-1/2"

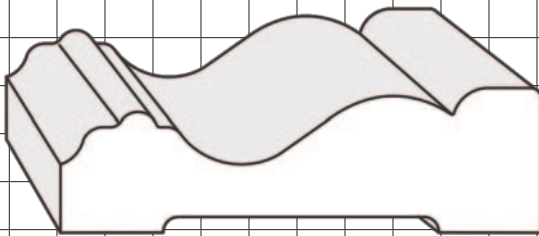

WM502
3/4" X 2-1/2"

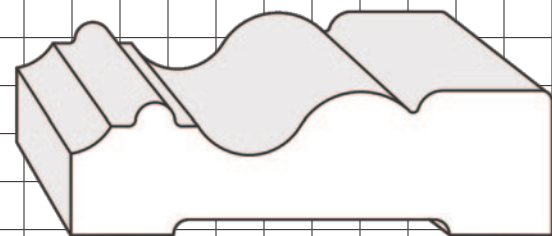

WM504
3/4" X 2-1/2"

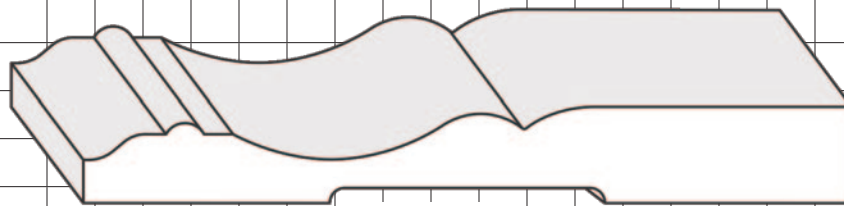

WM512
1/2" X 4"

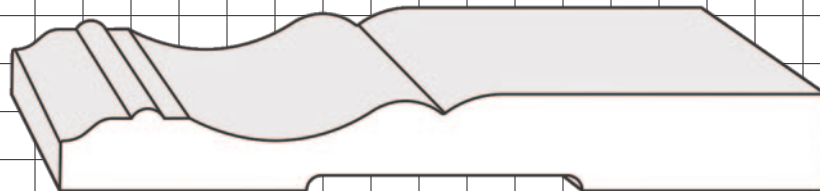

WM515
1/2" X 4"

CHAIR RAILS

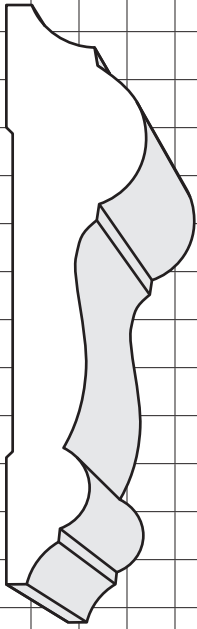

WM297
1 1/16" X 3"

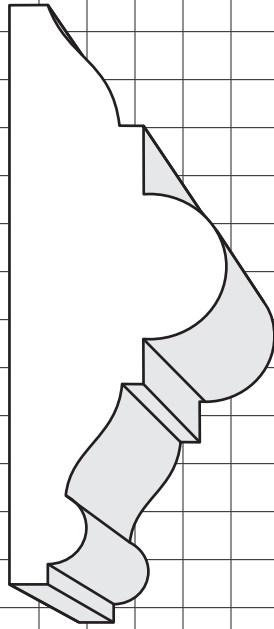

WM300
1-1/16" X 3"

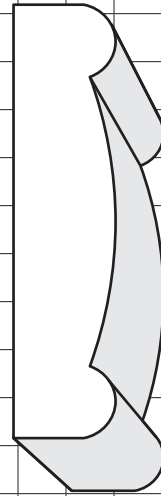

WM304
1/2" X 2-1/4"

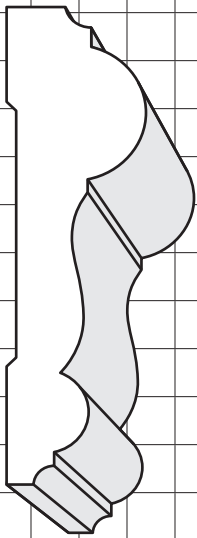

WM298
1 1/16" X 2-1/2"

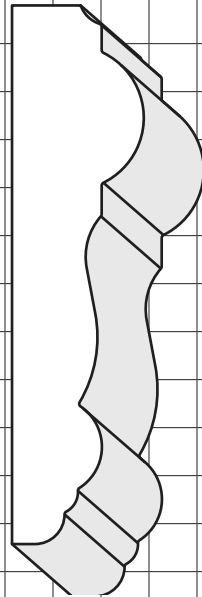

MK801
21/32" X 2-11/16"

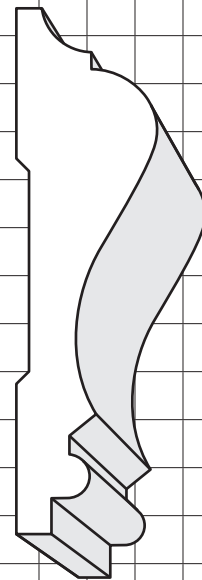

WM390
1 1/16" X 2-5/8"

COVES

These moldings require both a top and back knife.
See the picture glossary on page 57 to view a Back Knife.

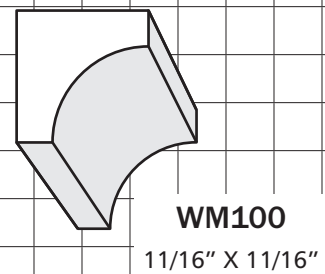
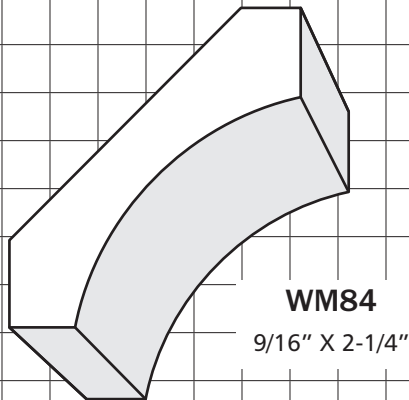
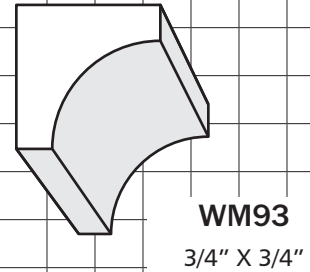
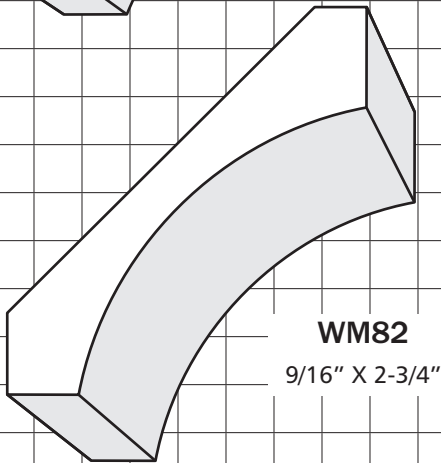
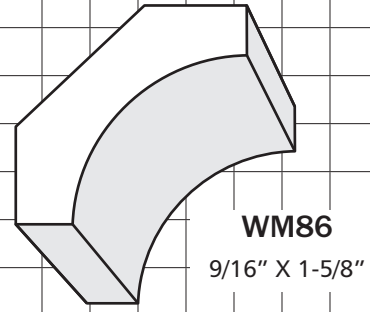
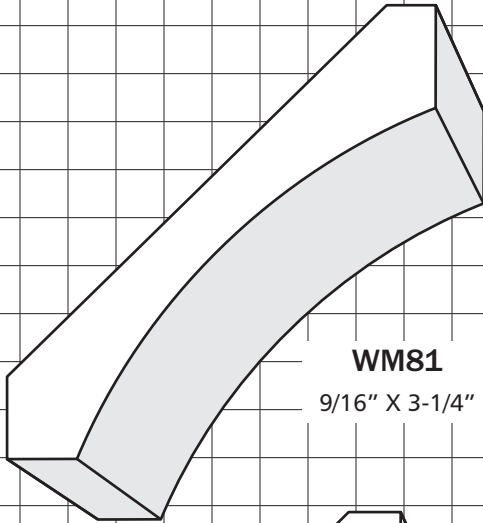

CROWN MOLDING

These moldings require both a top and back knife.

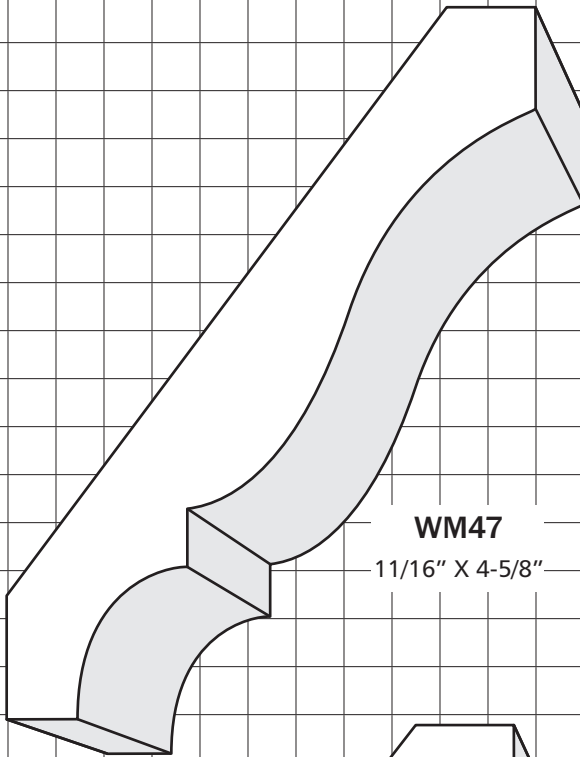

WM47
11/16" X 4-5/8"

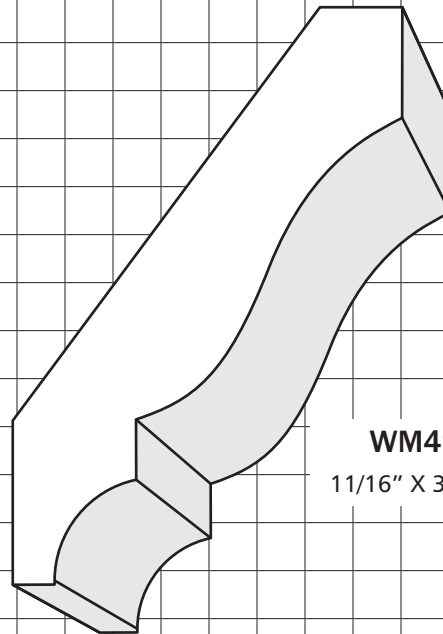

WM49
11/16" X 3-5/8"

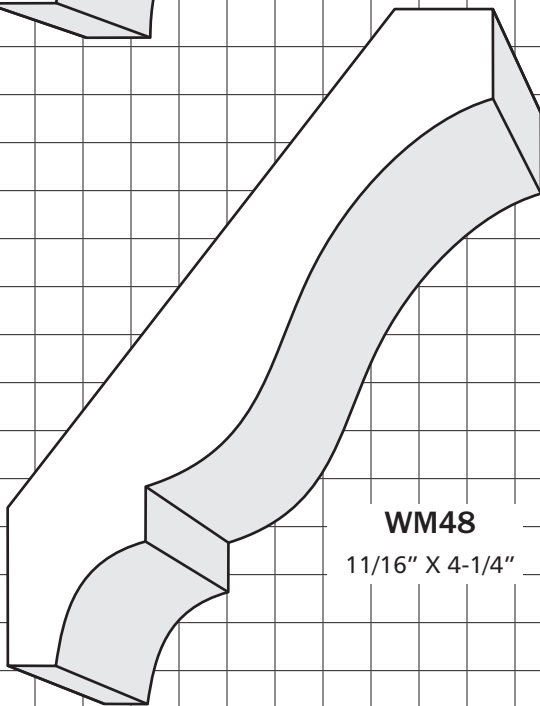

WM48
11/16" X 4-1/4"

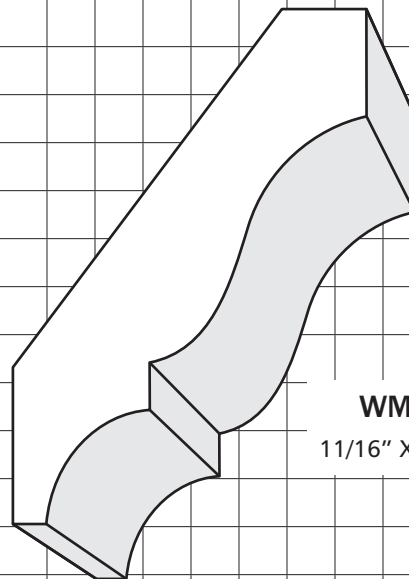

WM51
11/16" X 3-1/4"

See Miscellaneous section for crown molding with space for inserting rope or dentil molding.

CROWN MOLDINGS

These moldings require both a top and back knife.

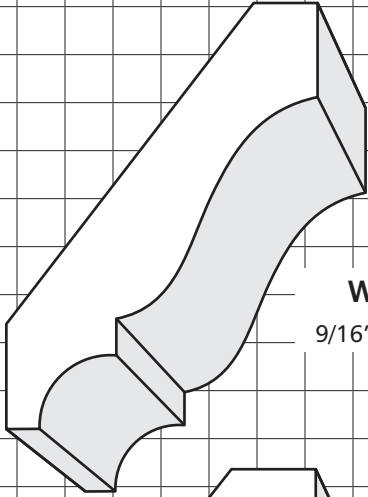

WM52
9/16" X 2-3/4"

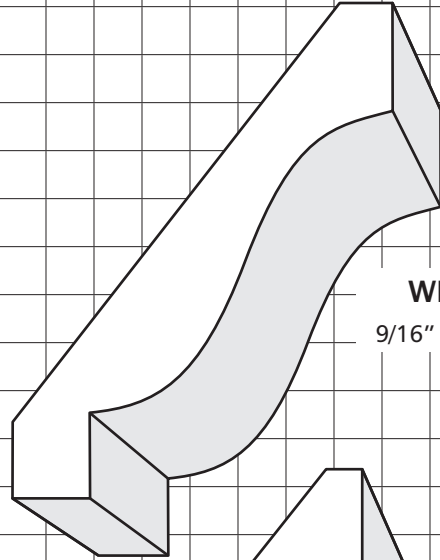

WM57
9/16" X 3-1/4"

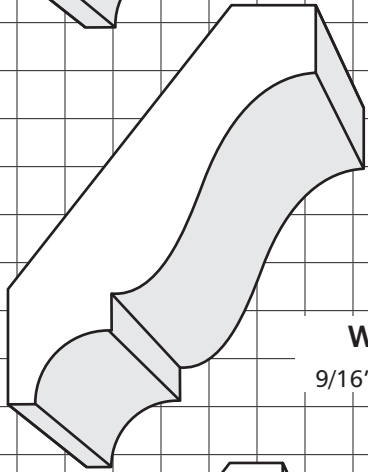

WM53
9/16" X 2-5/8"

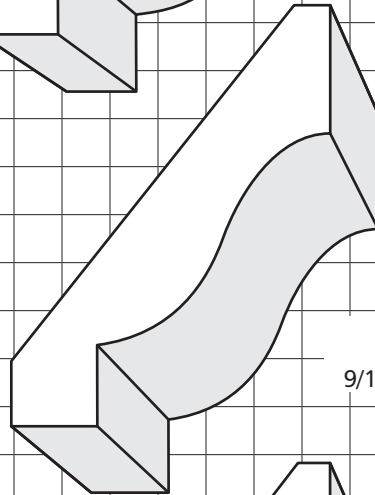

WM58
9/16" X 2-3/4"

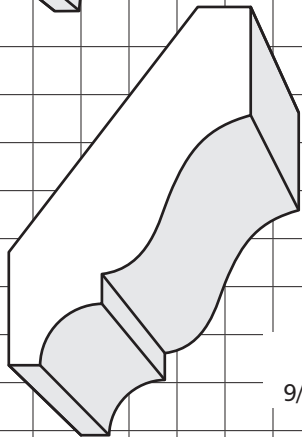

WM54
9/16" X 2-1/4"

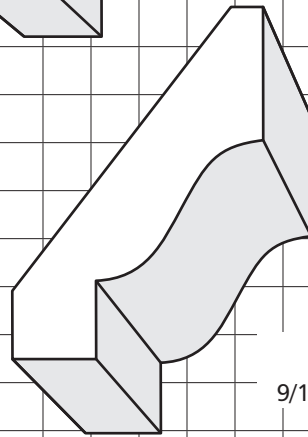

WM59
9/16" X 2-1/4"

See Miscellaneous section for crown molding with space for inserting rope or dentil molding.

CROWN MOLDINGS

These moldings require both a top and back knife.

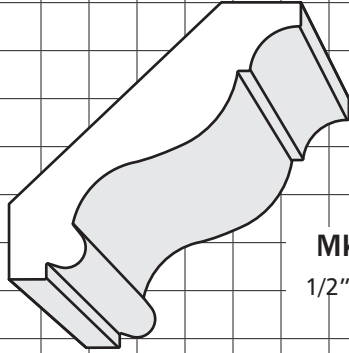

MK0044
1/2" X 2-1/8"

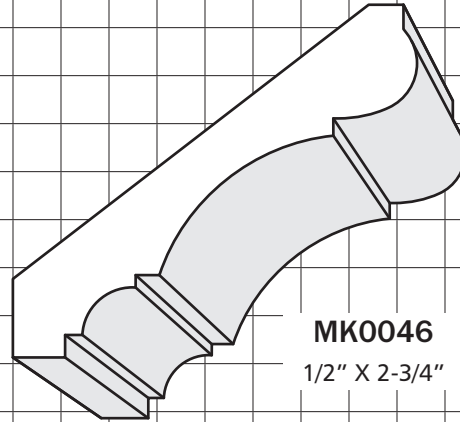

MK0046
1/2" X 2-3/4"

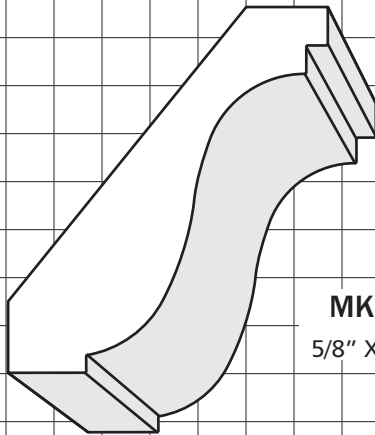

MK0045
5/8" X 2-9/16"

See Miscellaneous section for crown molding with space for inserting rope or dentil molding.

CROWN BACK SPLIT KNIFE SETS

Custom configurations are also available.

See page 57 for an example of a full-width crown back knife.

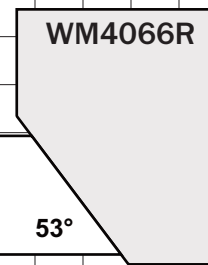
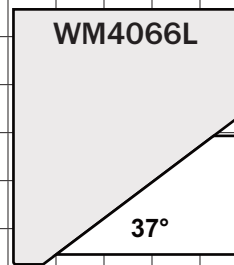
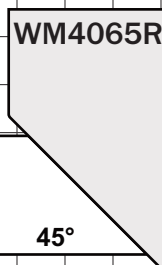
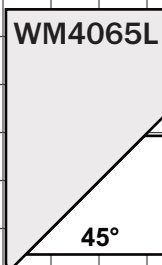

CROWN MOLDINGS

These moldings require both a top and back knife.

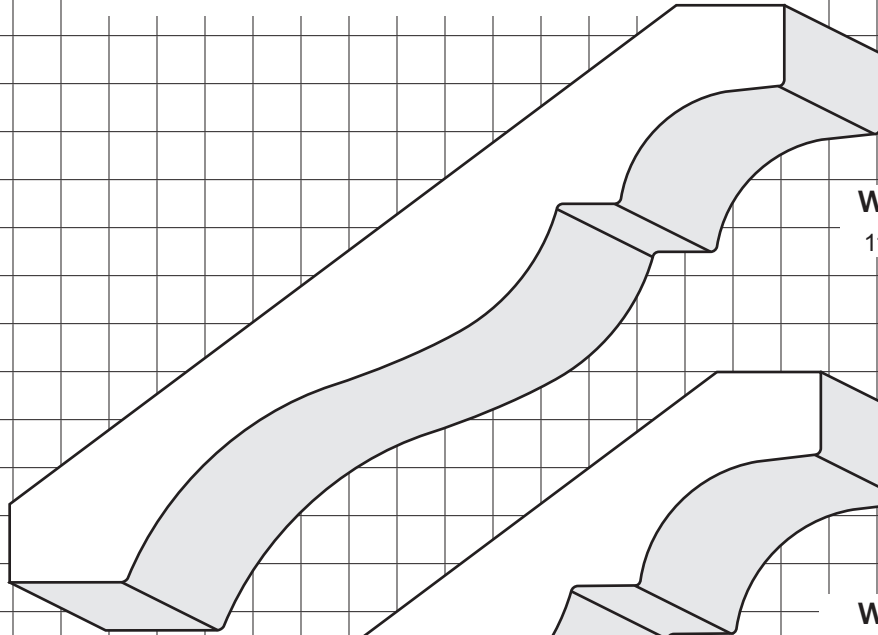

WM4020
11/16" X 5"

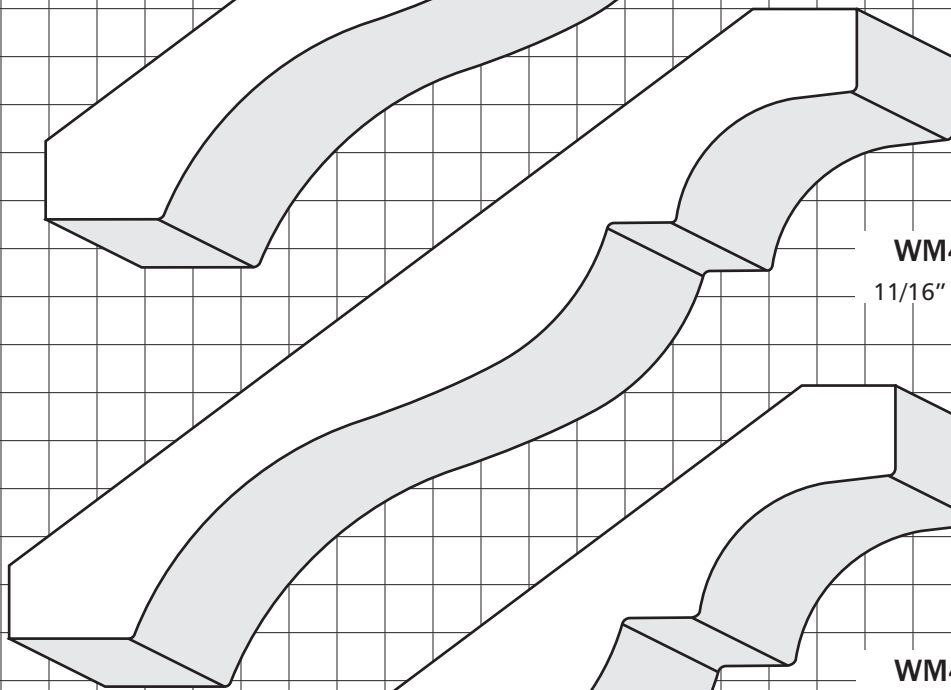

WM4022
11/16" X 5-1/2"

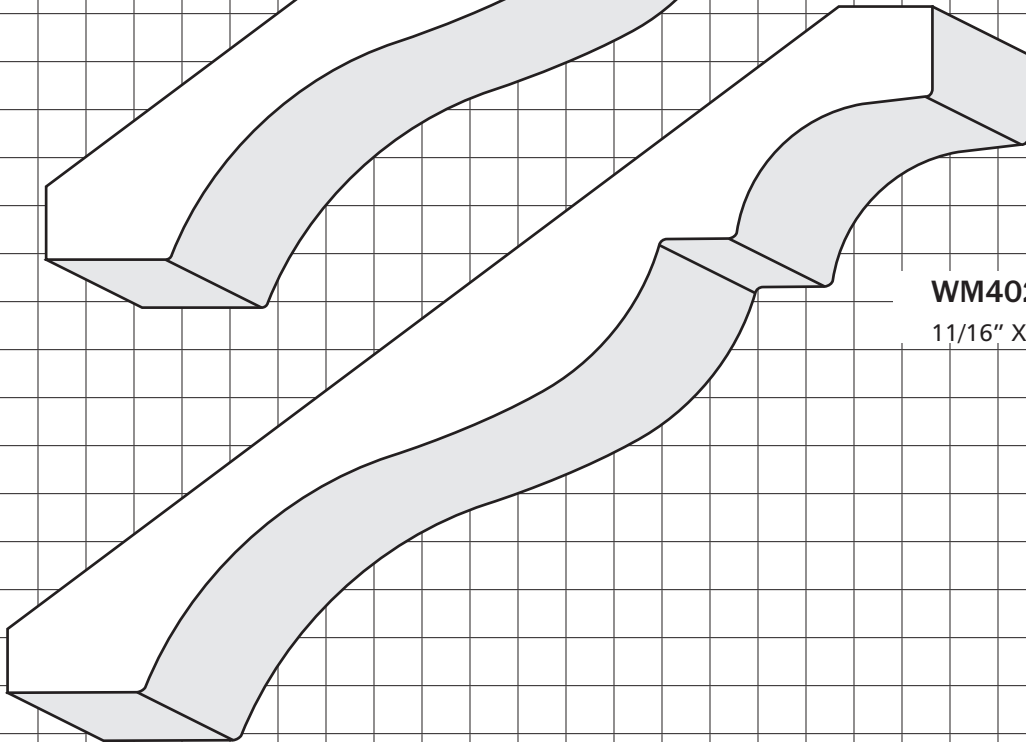

WM4024
11/16" X 6"

See Miscellaneous section for crown molding
with space for inserting rope or dentil molding.

CROWN MOLDINGS

These moldings require both a top and back knife.

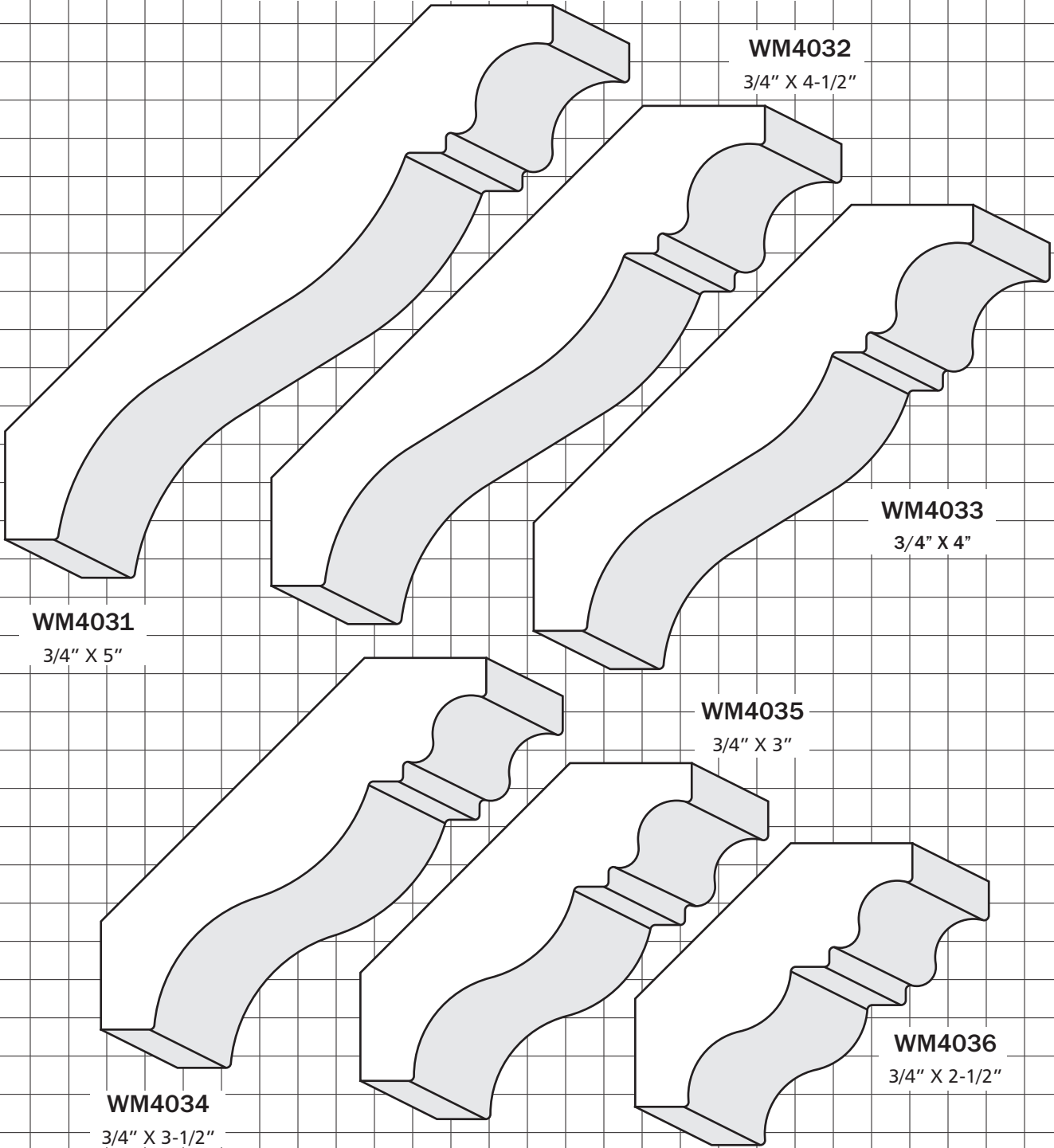

See Miscellaneous section for crown molding with space for inserting rope or dentil molding.

DECKING

See the picture glossary on page 58 to view a Vertical Run board.

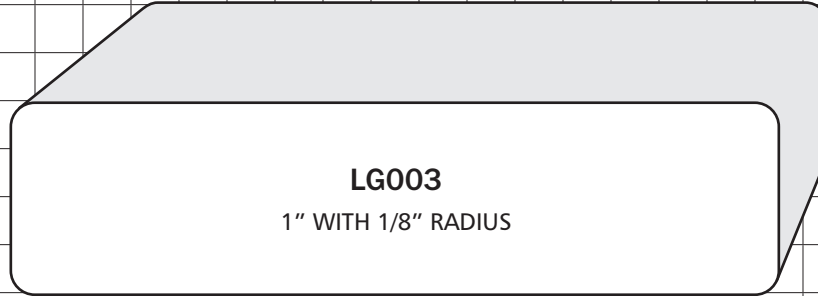

LG003

1" WITH 1/8" RADIUS

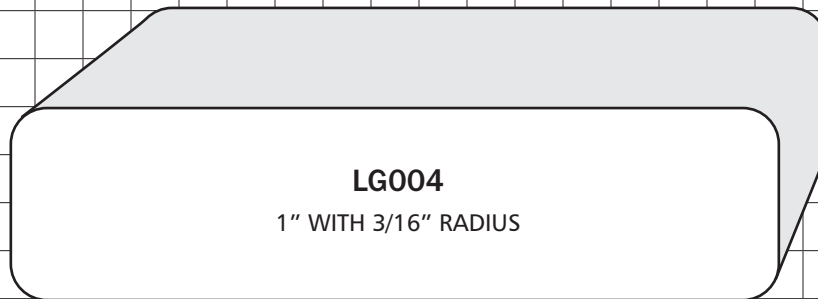

LG004

1" WITH 3/16" RADIUS

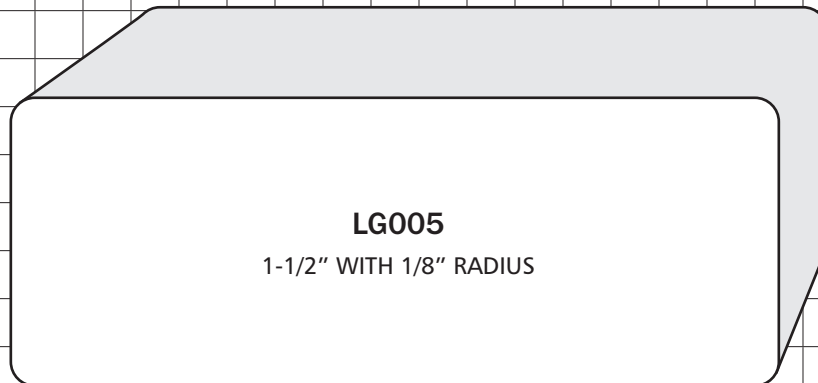

LG005

1-1/2" WITH 1/8" RADIUS

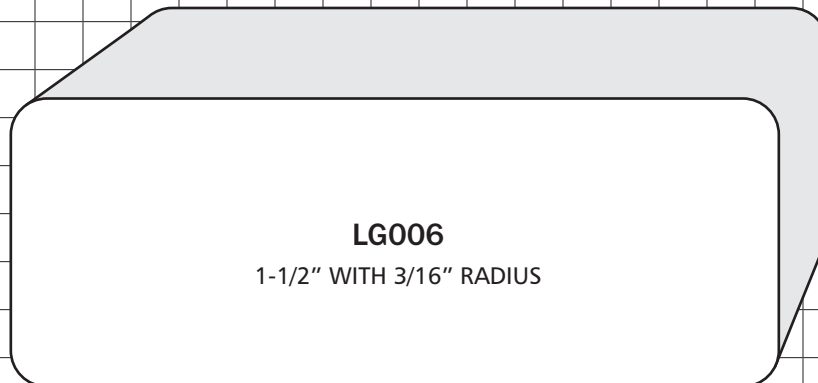

LG006

1-1/2" WITH 3/16" RADIUS

DOOR STOPS

Open-ended knives are available for some of these profiles.
Various widths of full-width knives are available.

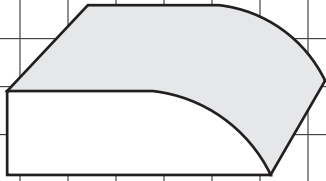

WM817 7/16" X 1-1/4"

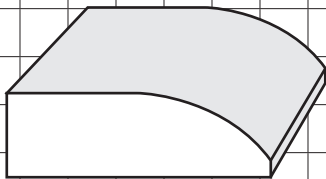

WM847 7/16" X 1-1/4"

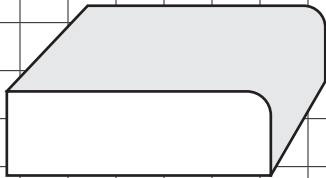

WM877 7/16" X 1-1/4"

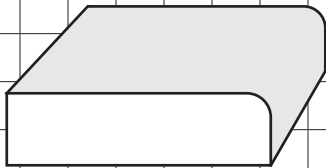

WM887 3/8" X 1-1/4"

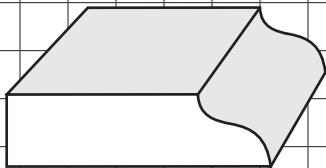

WM917 3/8" X 1-1/4"

DOWELLING / HALF ROUNDS

Half round knives will also produce dowelling and are recommended in 2-up knives.

These knives are available in a great variety of sizes. Check with us!

See the picture glossary on page 58 to view a tray.

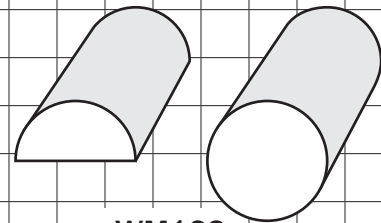
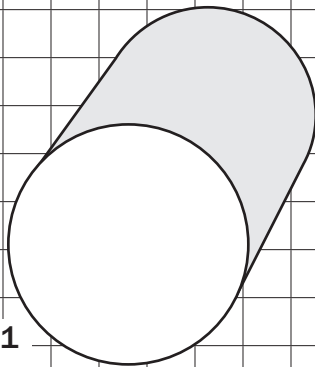
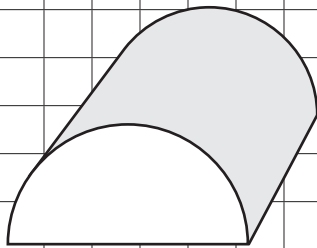
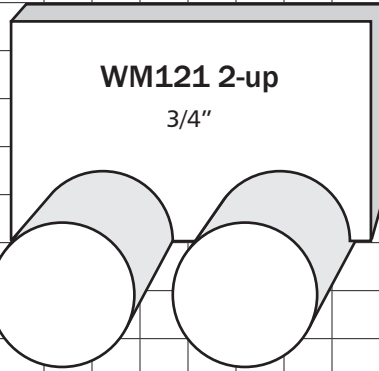

WM123
5/8"

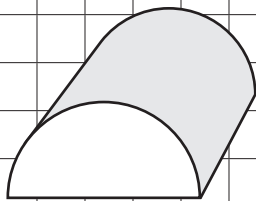

MK0501
1-1/4"

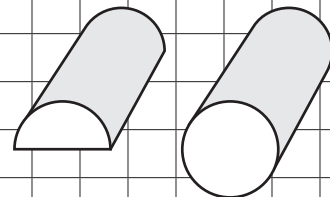
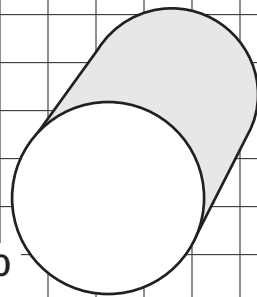

WM124
1/2"

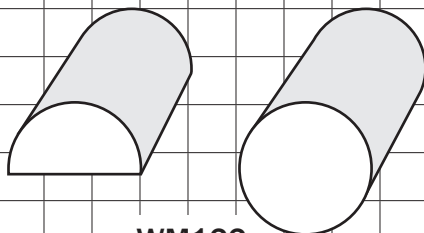

WM120
1"

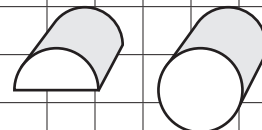

MK0502
7/16"

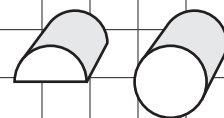

MK0503
3/8"

HAND RAIL

Two cuts using the same knife are required to produce these moldings.

Rabbit and tray knives are sold separately.

See the picture glossary on page 58 to view a tray.

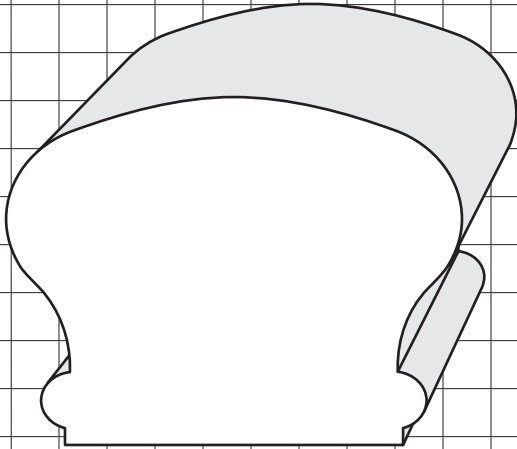

WM1000

2-3/8" X 1-13/16"

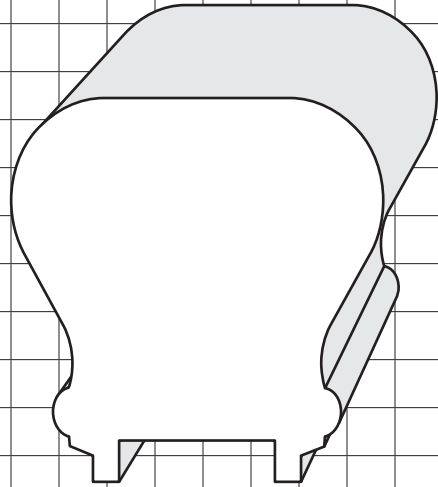

WM1001

1-15/16" X 2"

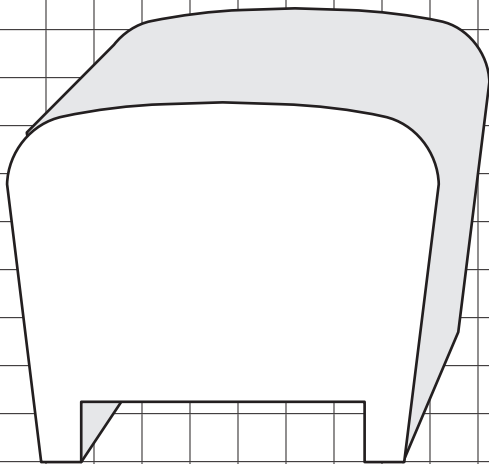

WM1002

2-1/4" X 1-7/8"

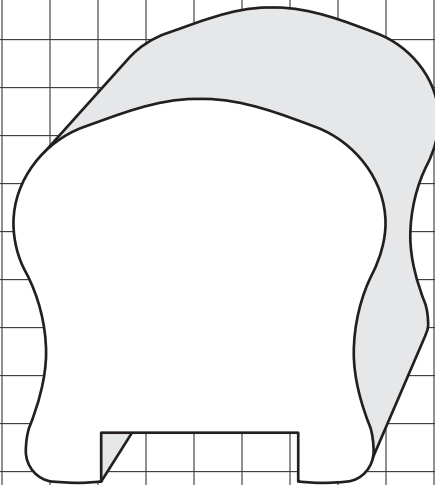

WM1004

1-15/16" X 2"

LOG SIDING

A matched set of three open-ended knives must be used for the top profile.

Rabbit knives are sold separately.

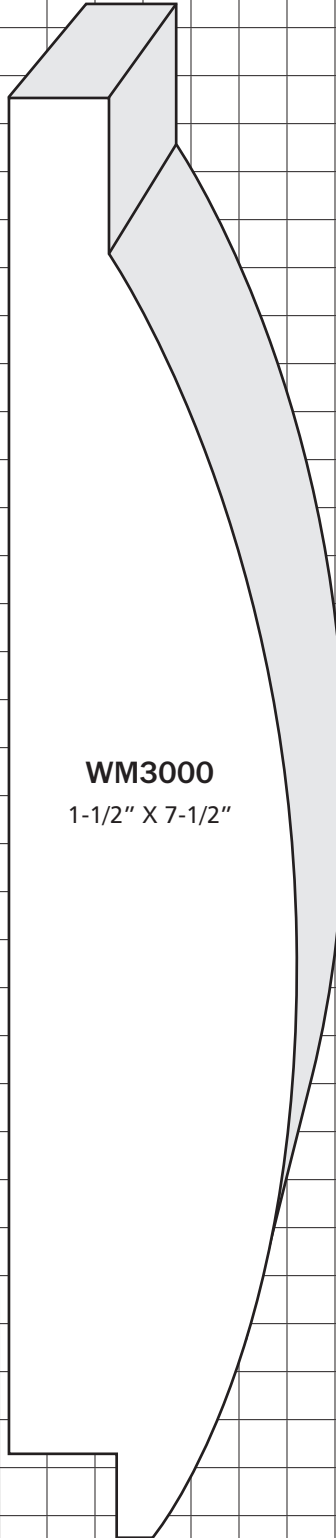

WM3000
1-1/2" X 7-1/2"

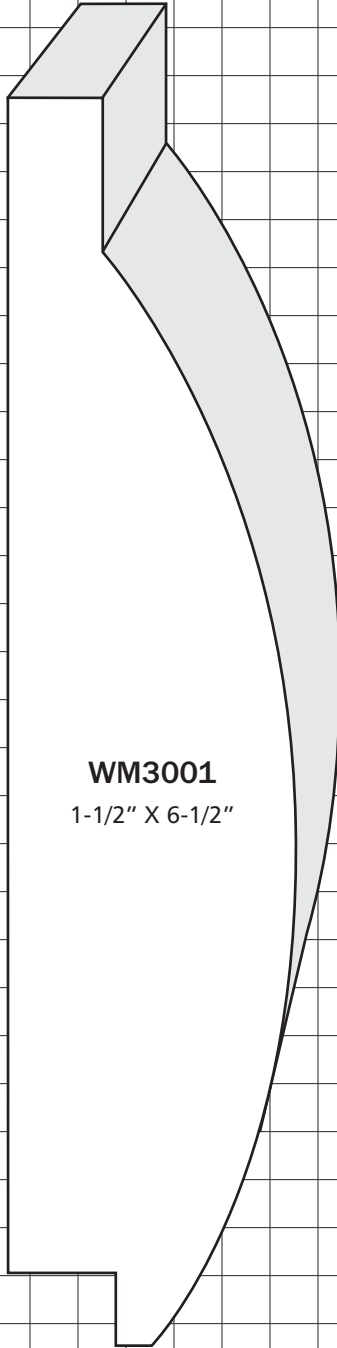

WM3001
1-1/2" X 6-1/2"

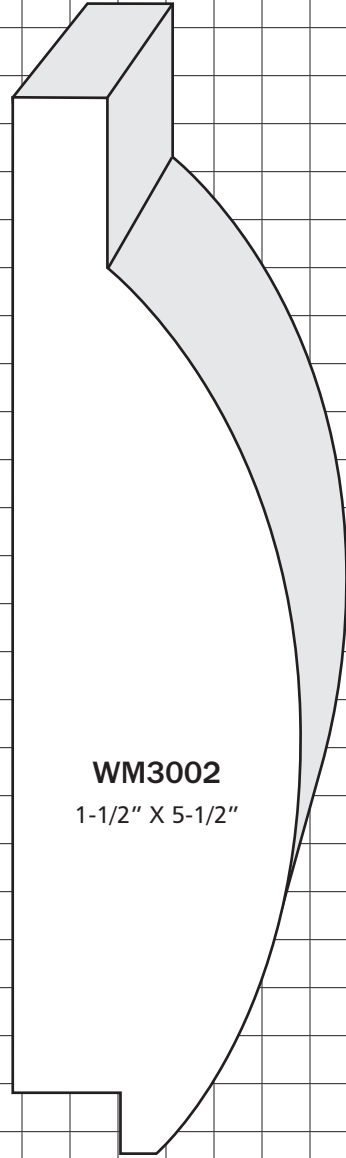

WM3002
1-1/2" X 5-1/2"

LOG SIDING

A matched set of three open-ended knives must be used for the top profile.

Rabbit knives are sold separately.

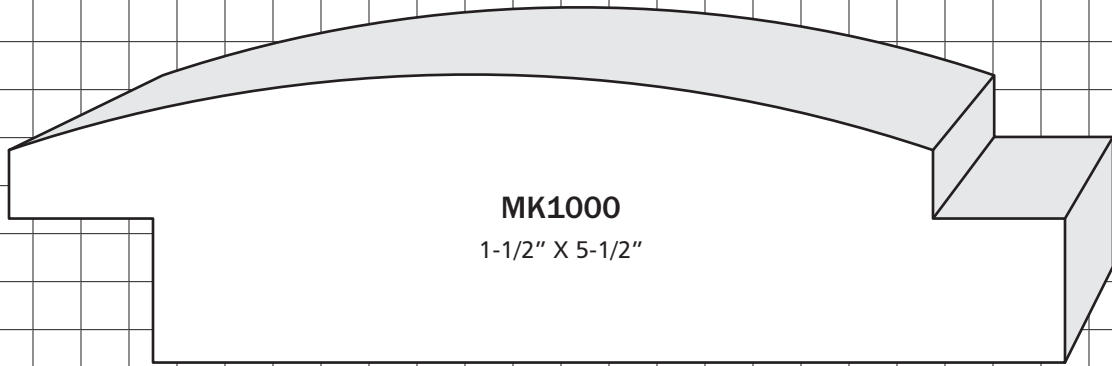

MK1000

1-1/2" X 5-1/2"

MK1000 FITS MOST MOLDERS INCLUDING LOGOSOL PH260

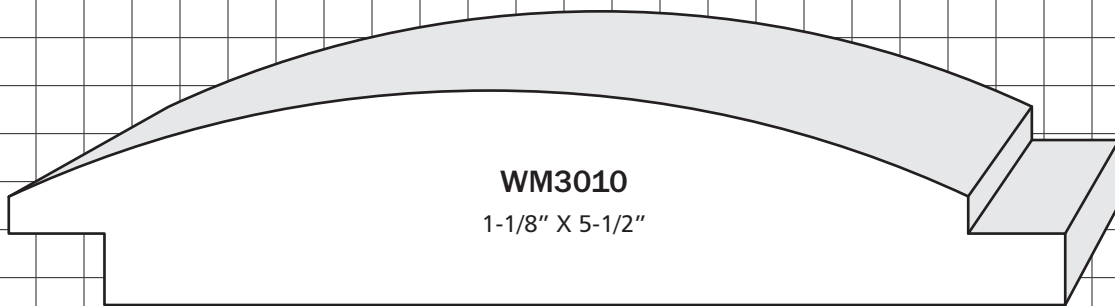

WM3010

1-1/8" X 5-1/2"

WM3010 & WM3012 FIT MACHINES THAT ARE CAPABLE OF A 3/4" DEEP CUT

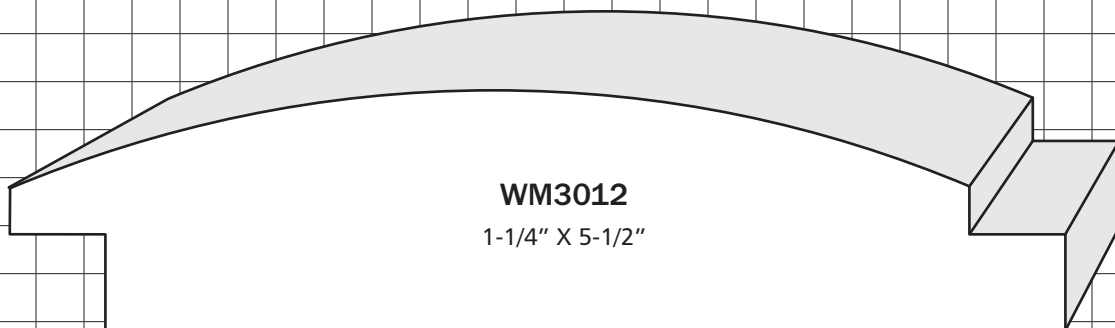

WM3012

1-1/4" X 5-1/2"

MITRED DOORS

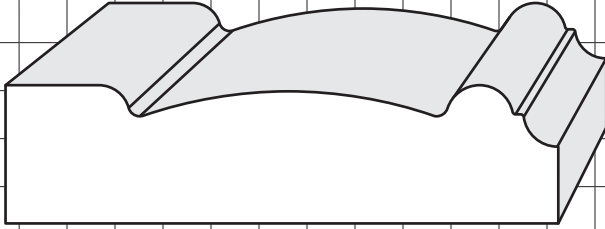

MD001

3/4" X 3"

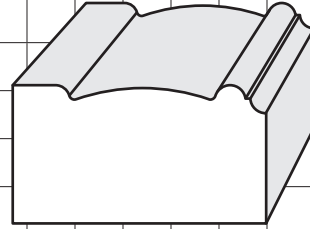

MD009

3/4" X 1-3/8"

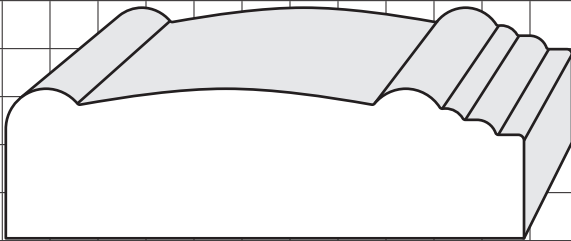

MD002

13/16" X 2-13/16"

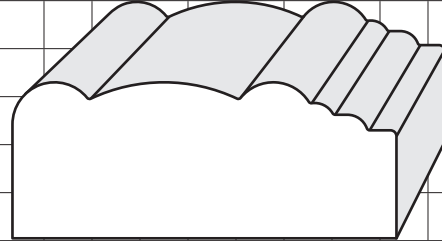

MD012

13/16" X 2

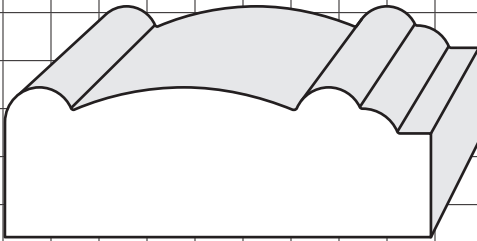

MD003

13/16" X 2-5/16"

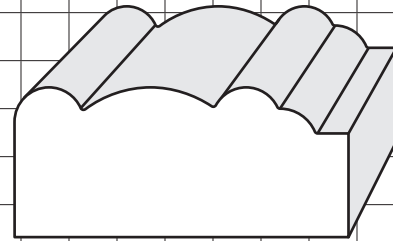

MD008

13/16" X 1-13/16"

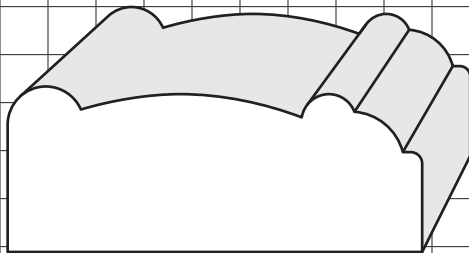

MD004

1" X 2-1/4"

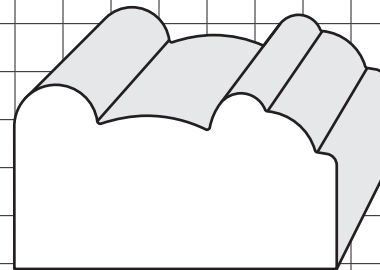

MD007

1" X 1-3/4"

MITRED DOORS

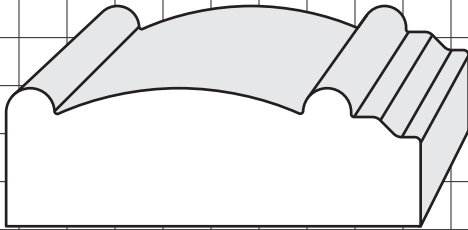

MD005
3/4" X 2-1/4"

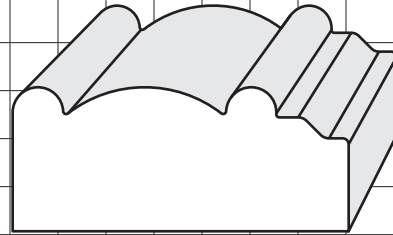

MD013
3/4" X 1-3/4"

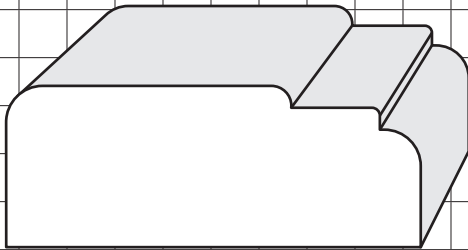

MD006
7/8" X 2-1/4"

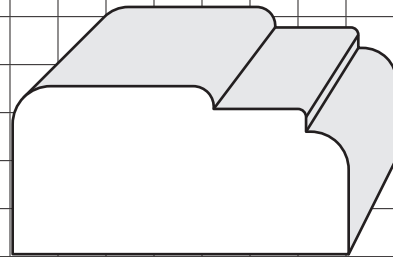

MD014
7/8" X 1-3/4"

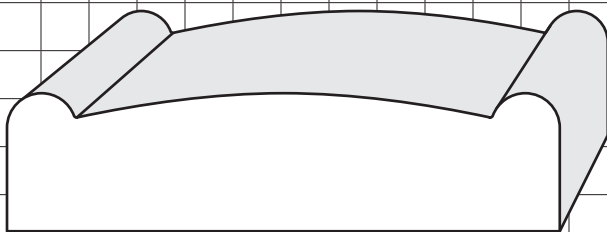

MD010
3/4" X 3"

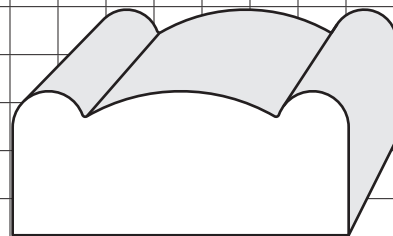

MD015
3/4" X 1-3/4"

PANEL STRIPS / MULLION CASINGS

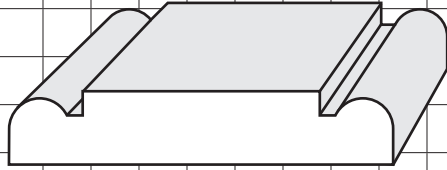

WM955	3/8" X 2-1/4"
WM956	3/8" X 2" (Illus.)
WM957	3/8" X 1-3/4"

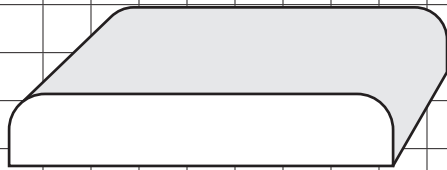

WM970	3/8" X 2-1/4"
WM972	3/8" X 2" (Illus.)
WM973	3/8" X 1-3/4"

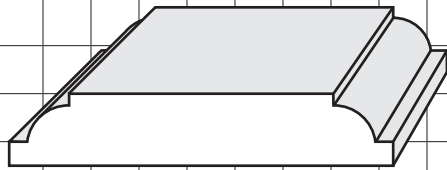

WM975	3/8" X 2-1/4"
WM977	3/8" X 2" (Illus.)
WM978	3/8" X 1-3/4"

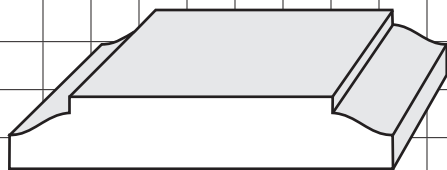

WM985	3/8" X 2-1/4"
WM987	3/8" X 2" (Illus.)
WM988	3/8" X 1-3/4"

PICTURE FRAMES

Rabbit knives are sold separately.

Try our CK387s2 Rabbit knife found on page 54 in our Miscellaneous Section.

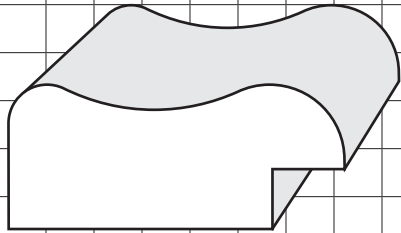

PF-1

3/4" X 1-3/4"

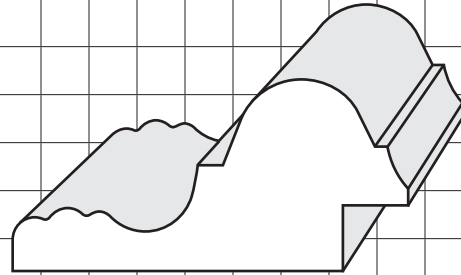

PF-15

1" X 2-1/16"

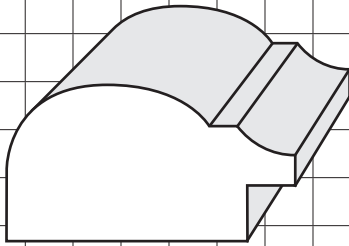

PF-4

1-3/16" X 1-1/2"

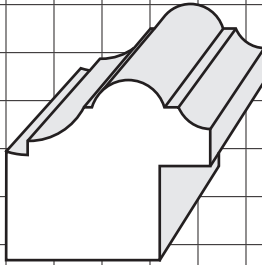

PF-17

15/16" X 1-1/16"

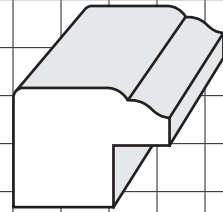

PF-18

5/8" X 13/16"

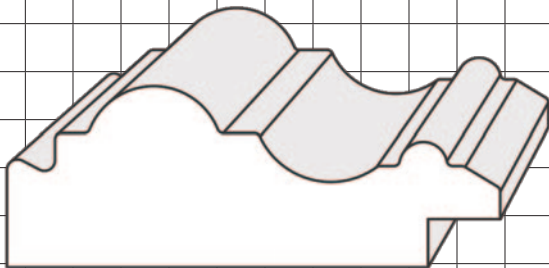

PF-8

15/16" X 2-9/16"

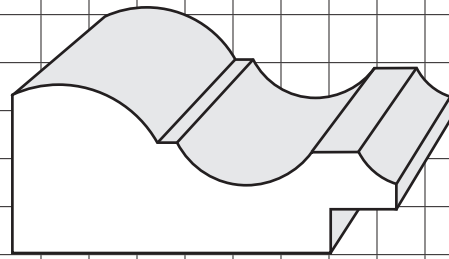

PF-20

7/8" X 2"

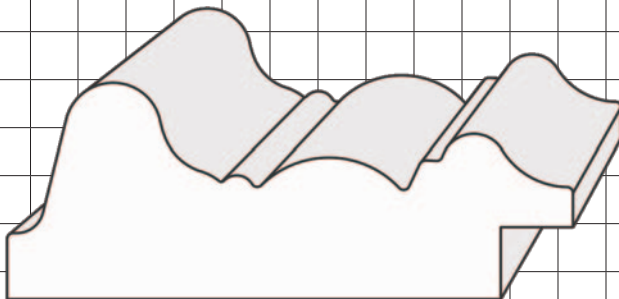

PF-14

1-1/8" X 2-15/16"

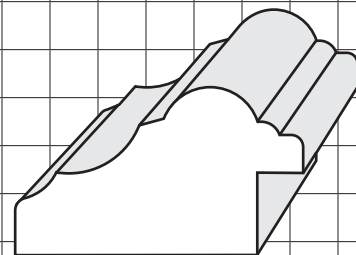

PF-35

7/8" X 1-1/2"

PICTURE MOLDINGS

Available in top knives, back knives, and the popular VersaKnife style.

See the Picture Glossary on page 57 to view a VersaKnife.

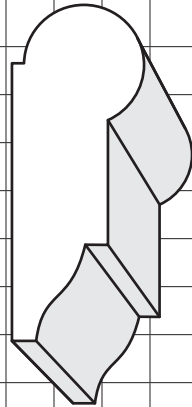

WM273

11/16" X 1-3/4"

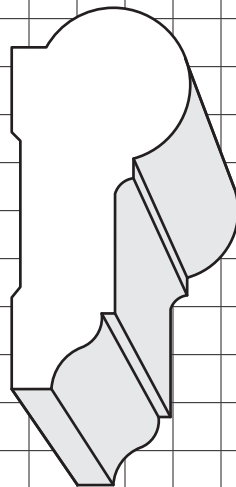

MK0031

15/16" X 2"

PLANTATION LOUVERS / SHUTTERS

See the picture glossary on page 58 to view a tray knife.

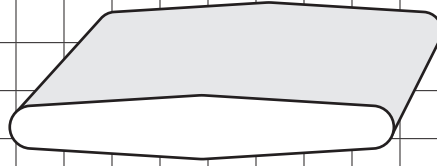

MK0048

21/64" X 2"

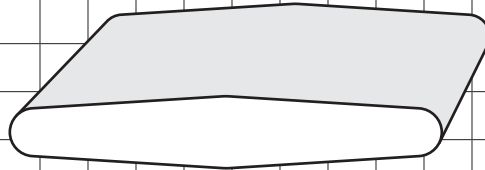

MK0049

3/8" X 2-1/4"

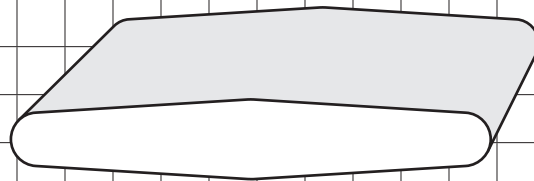

MK0050

27/64" X 2-1/2"

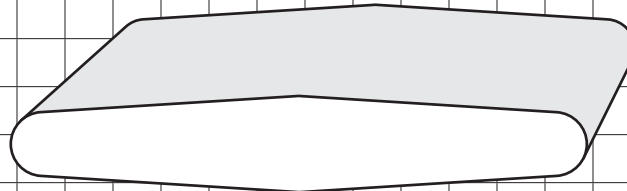

MK0051

1/2" X 3"

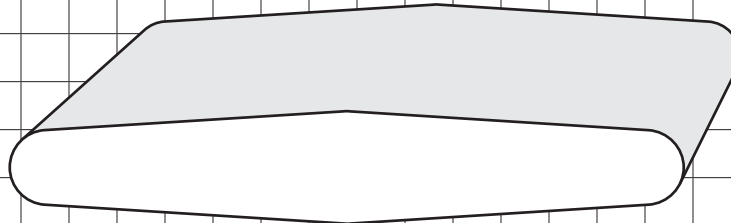

MK0530

19/32" X 3-1/2"

PLANTATION LOUVERS / SHUTTERS

See the picture glossary on page 58 to view a tray knife.



MK0052

21/64" X 2"

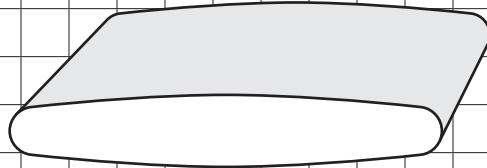

MK0053

3/8" X 2-1/4"

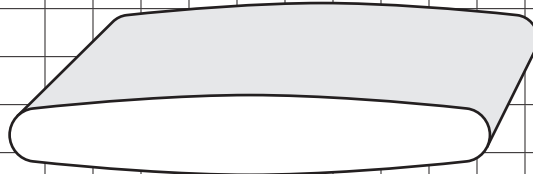

MK0054

27/64" X 2-1/2"



MK0055

1/2" X 3"

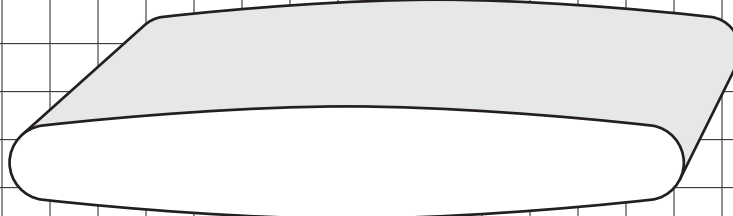

MK0540

19/32" X 3-1/2"

Open-ended knives available for these profiles.

PLINTH MOLDING

These moldings require a back relief knife.

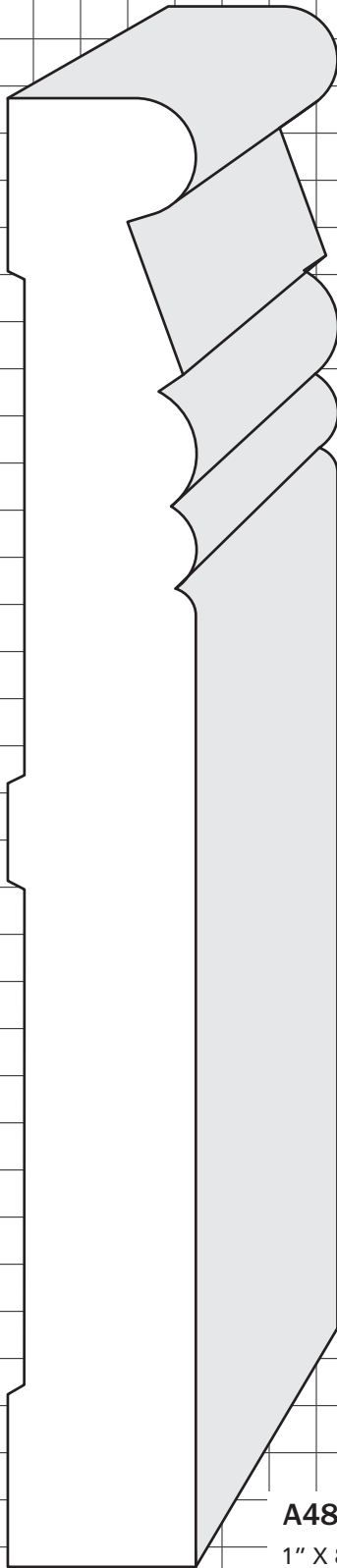

A48A
1" X 8"

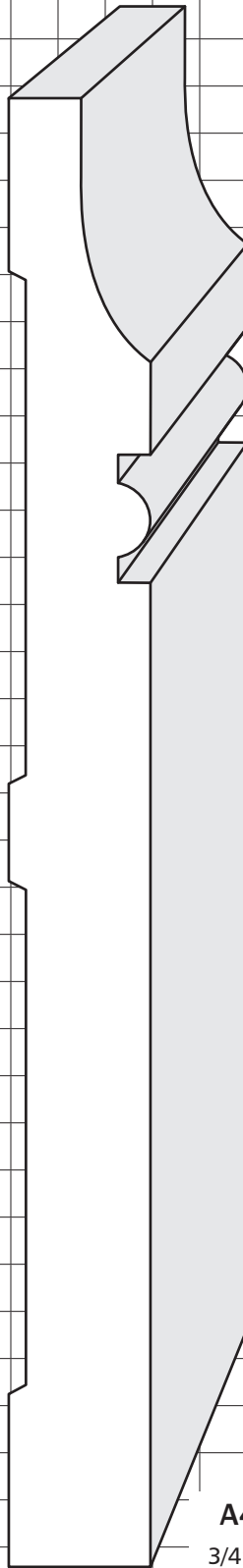

A49A
3/4" X 8"

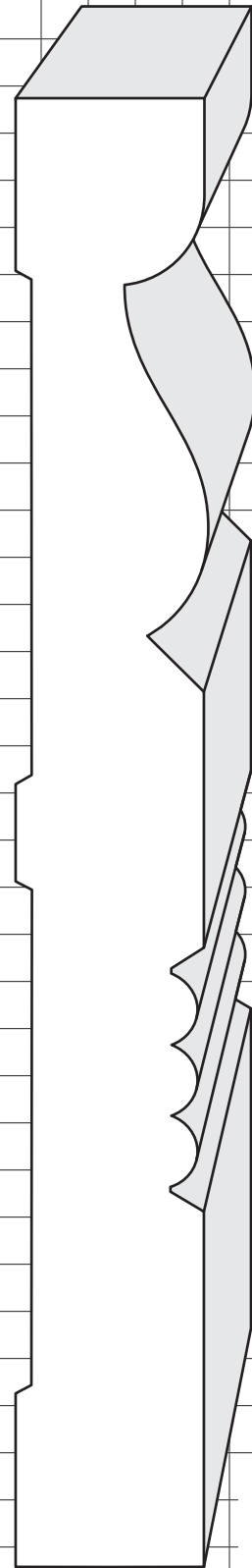

A50A
1" X 8"

QUARTER ROUNDS

Quarter Rounds that are $5/8$ " or thinner can be run as a 2-Up knife.

See the Picture Glossary on page 58 to view a 2-Up style knife.

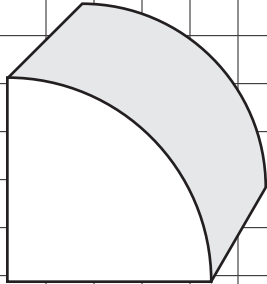

WM103

$1\text{-}1/16$ " X $1\text{-}1/16$ "

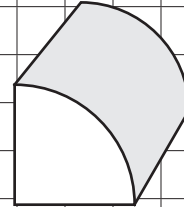

WM107

$5/8$ " X $5/8$ "

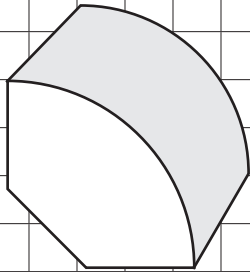

WM104

$11/16$ " X $11/16$ "

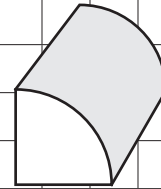

WM108

$1/2$ " X $1/2$ "

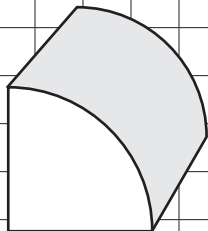

WM105

$3/4$ " X $3/4$ "

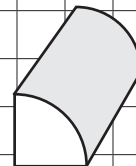

WM109

$3/8$ " X $3/8$ "

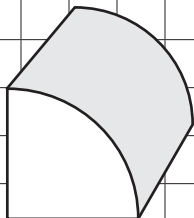

WM106

$11/16$ " X $11/16$ "



WM110

$1/4$ " X $1/4$ "

SHELF EDGE / SCREEN MOLD

See the picture glossary on page 58 to view a 2-Up style knife.

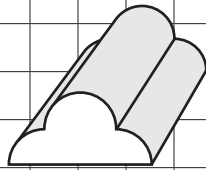

Wm137

3/8" X 3/4"

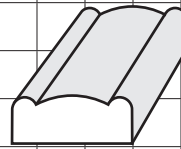

WM141

1/4" X 5/8"

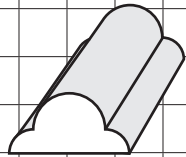

WM138

5/16" X 5/8"

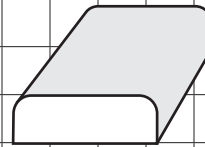

WM142

1/4" X 3/4"



WM140

1/4" X 3/4"

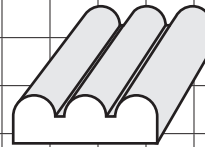

WM144

1/4" X 3/4"

TONGUE AND GROOVE

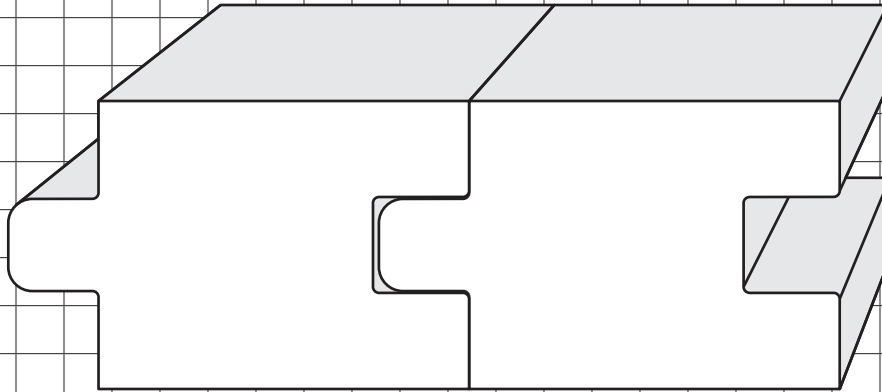

CK389

1-1/2"

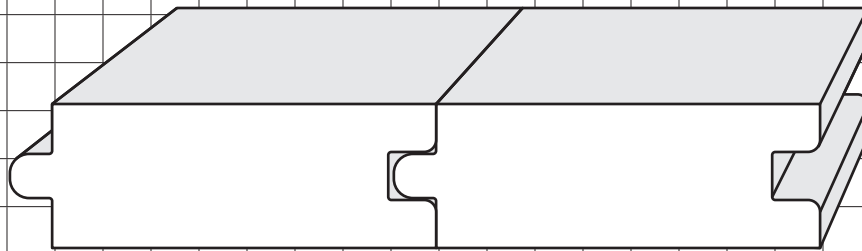

CK388

3/4"

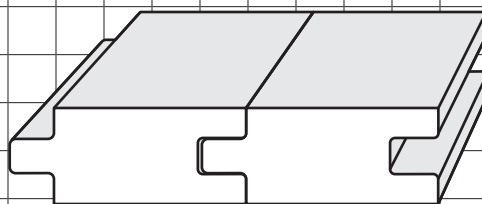

CK386

1/2"

Visit our web page for more tongue and groove options.

TONGUE AND GROOVE

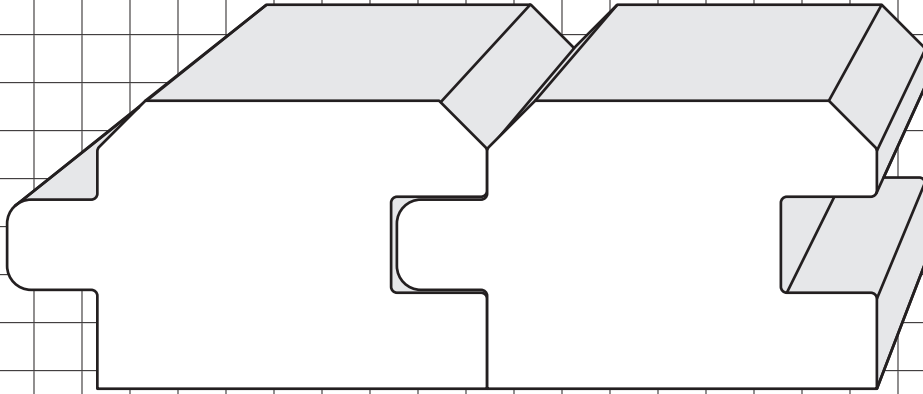

CK389V

1-1/2"

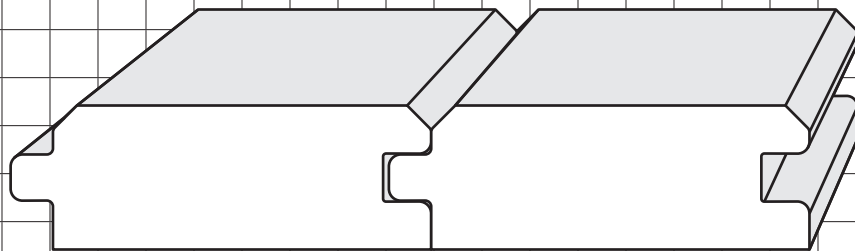

CK388V

3/4"

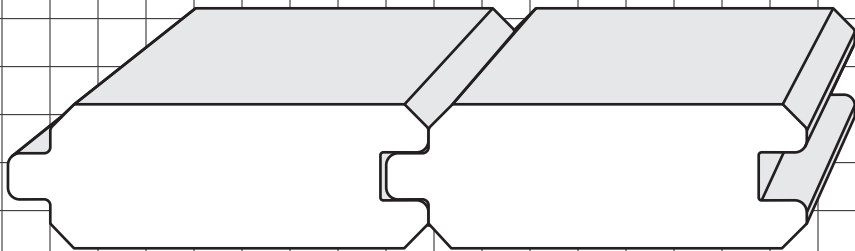

CK388DV

3/4"

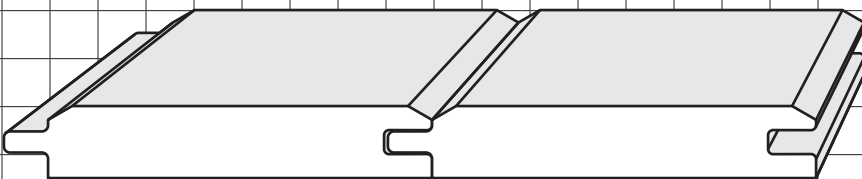

CK386V

1/2"

TONGUE AND GROOVE

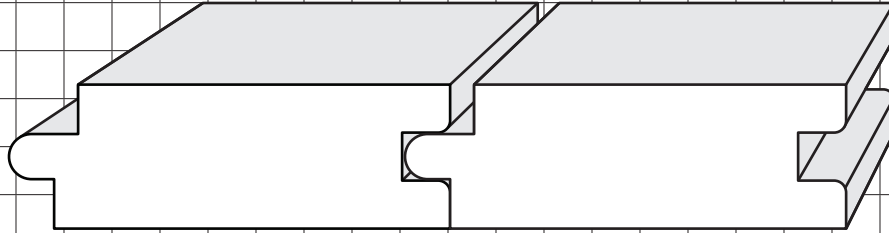

CK396

3/4"

*Special gap on face

Most tongue and grooves do not have a gap on the face
CK-394 (tongue knife) makes with a 1/16" gap on the face.
CK-396 (tongue knife) makes with a 1/8" gap on the face.
CK-398 (tongue knife) makes with a 1/4" gap on the face.
Different sizes of gaps are available.
LGCK390 is the groove knife for all of the above.

We make and sell wearable HDPE Plastic Cleats for your jig.

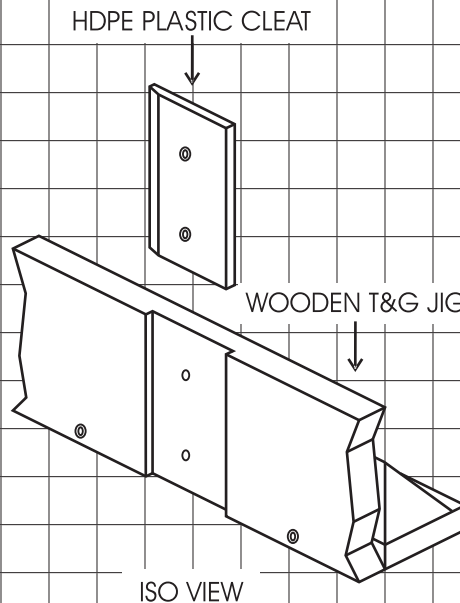

Part Number:
T&GCleat

Sold in sets of two (2).
Wooden jig not included.

TONGUE AND GROOVE - FLOORING

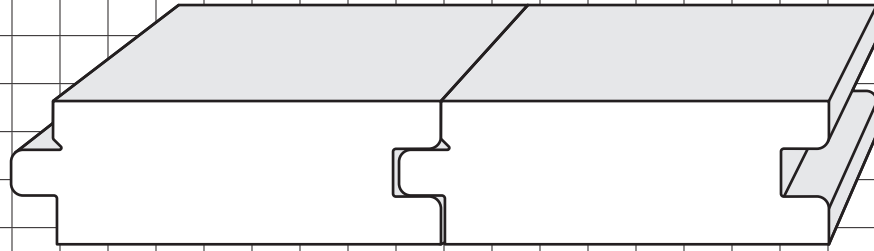

CK384A

3/4"

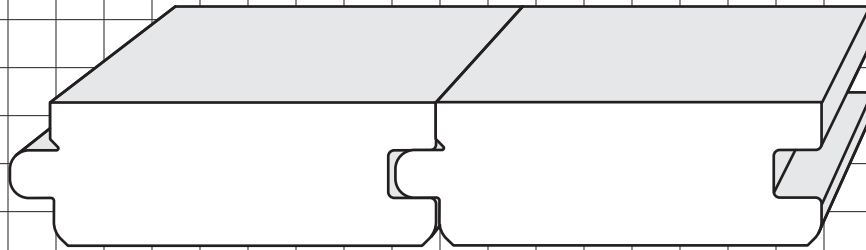

CK384C

3/4"

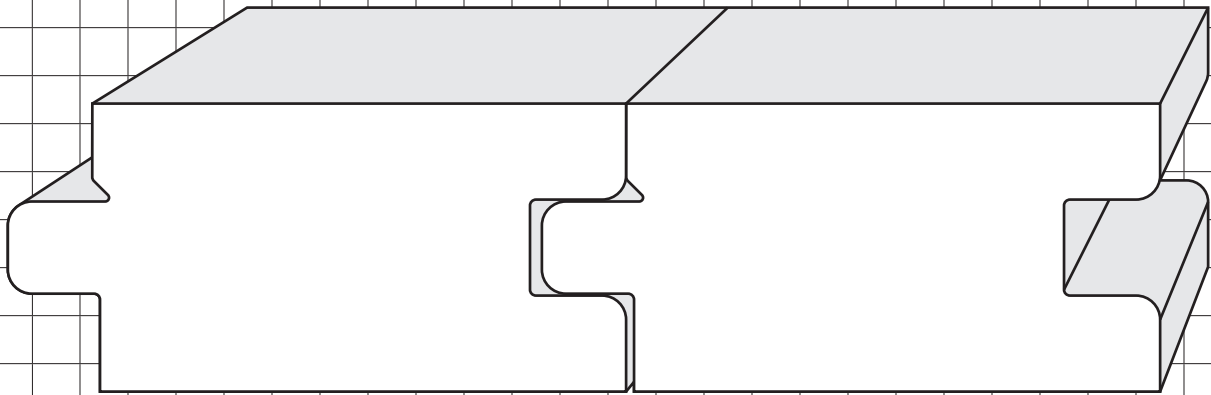

CK384E

1-1/2"

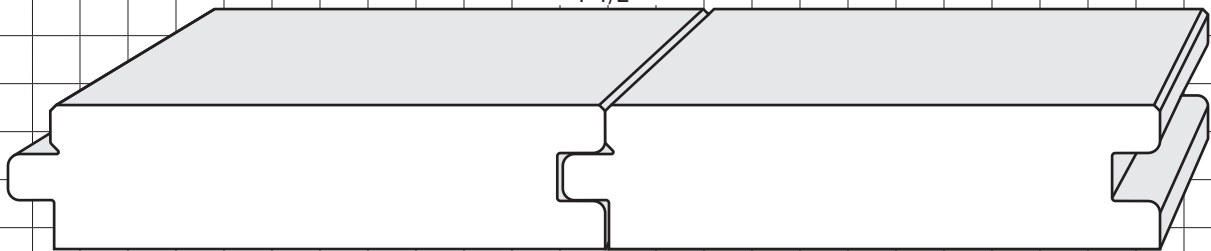

CK384F

3/4"

V's

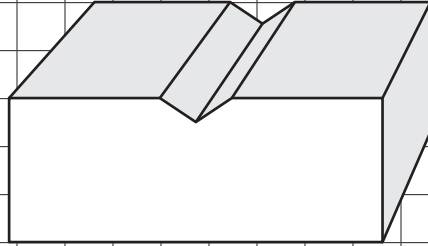

MK0958

3/8" wide X 1/8" deep (matches CK386V)

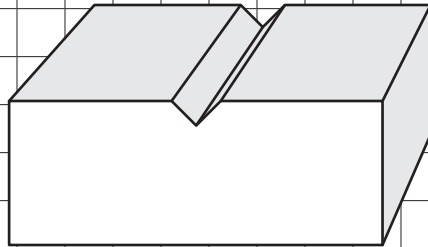

MK0110

1/4" wide X 1/8" deep (matches CK388V)

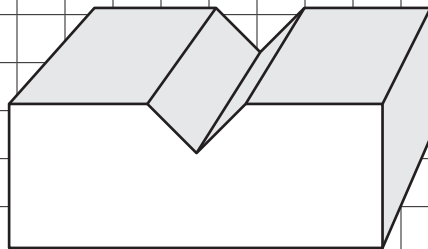

LGPS83T

1/2" wide X 1/4" deep (matches CK389V)

WAINSCOTTING

Rabbit knives are sold separately.



WM6000
3/8" X 2-1/2"

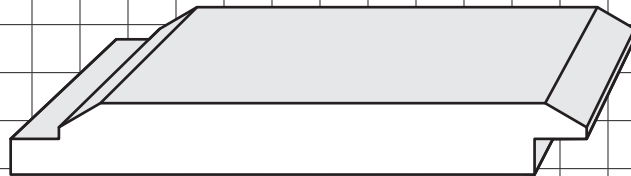

WM6001
3/8" X 3"

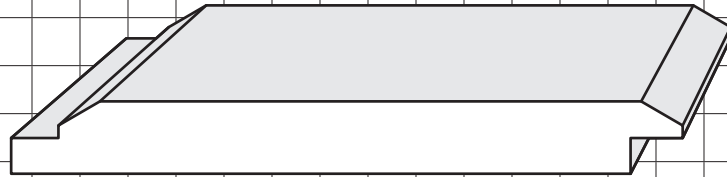

WM6002
3/8" X 3-1/2"

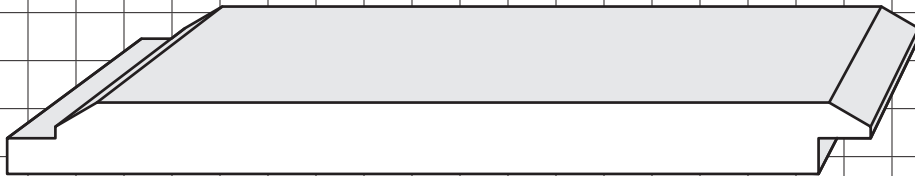

WM6004
3/8" X 4-1/2"

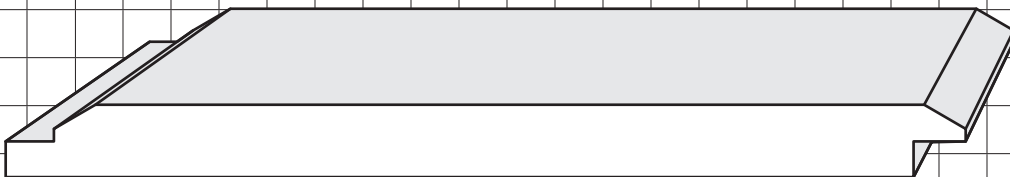

WM6005
3/8" X 5"

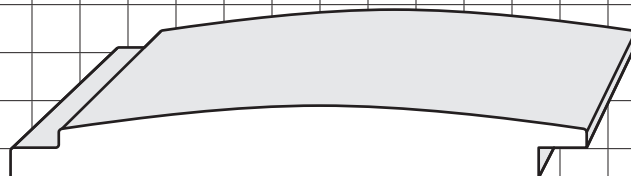

WM6007
3/8" X 3"

WOOD PLANK PANELLING

Rabbet knives are sold separately.

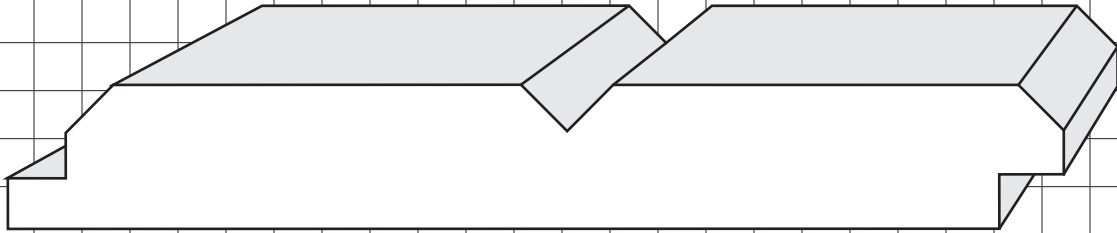

PS83

3/4" X 5-1/2"

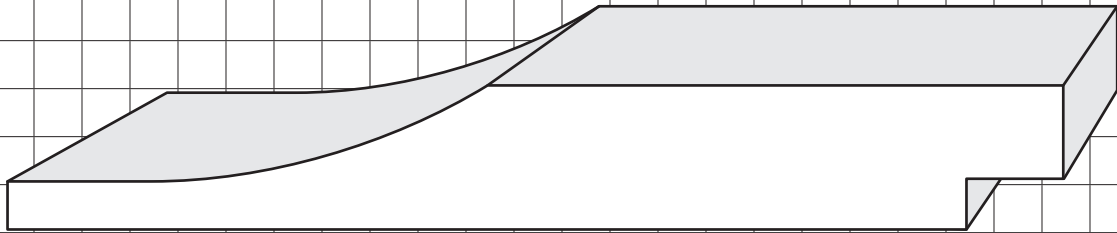
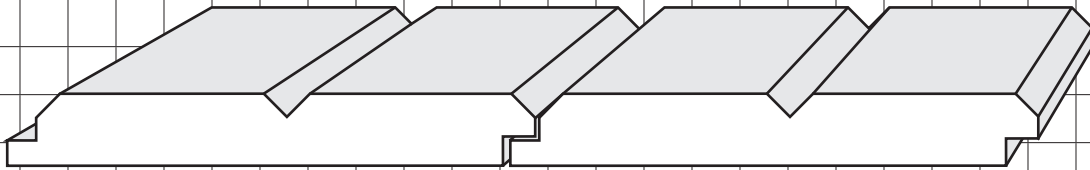

PS86

3/4" X 5-1/2"

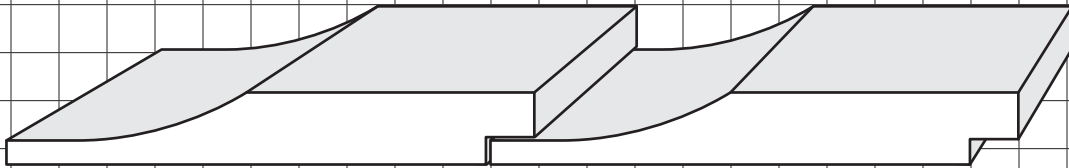

WOOD PLANK PANELLING

Rabbit knives are sold separately.

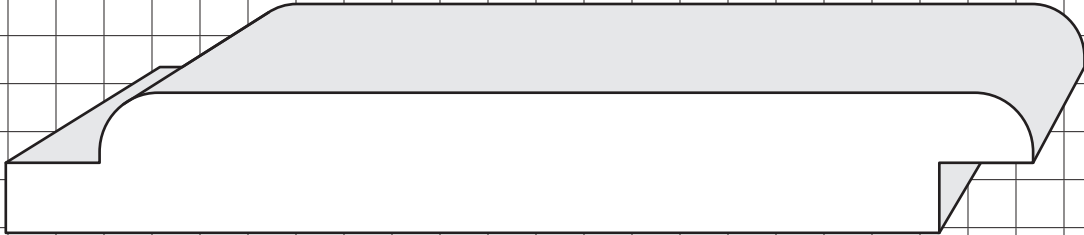

PS87

3/4" X 5-1/2"

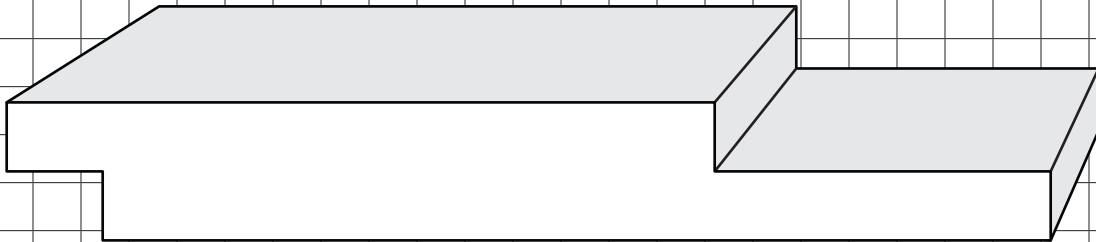
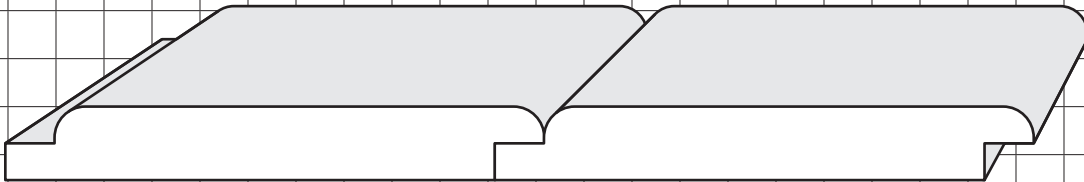

PS150

22/32" X 5-7/16"

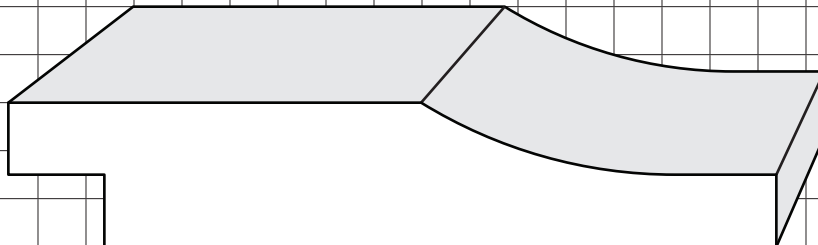

MK0085

3/4" X 4"

MISCELLANEOUS

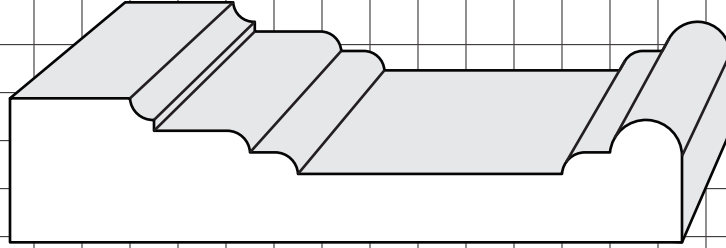

MK0098

3/4" X 3-1/2"

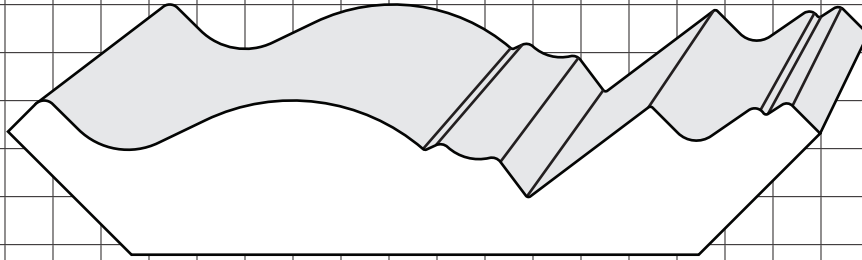

MK0843

13/16" X 4-1/4"

Insert space for rope or dentil molding.

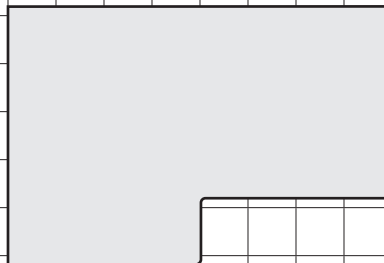

CK387s2

Stepped Rabbet Knife

Machine Rabbets up to 1" wide and 1/8" to 5/8" Deep.

MOLDINGKNIVES.COM CUSTOM PATTERN KNIVES

CAUTION: Each moldingknives.com profile knife is carefully machined, weighed and correctly matched to the gib and counter-balances included with that particular knife. Keep each knife with its own gib and weights. Never use gibs or weights from any other custom knives you may have purchased. Use of improperly matched gibs and weights may cause excessive vibration and damage to the cutter head bearings.

NOTE: If you have ordered a knife to be used in the three-slot cutter head; do not use the gib supplied to secure this knife in the single knife holder. The weight of this gib may be different.

IMPORTANT: After running approximately 10 linear feet, stop the machine and retighten the gibs!

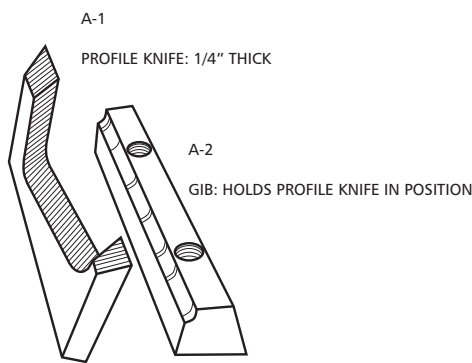
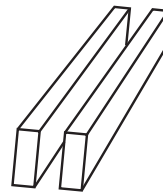
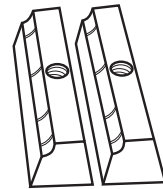

FIG. A



A-3

STEEL COUNTER-BALANCE WEIGHTS (2) TO BE SECURED BY GIBS



A-4

GIBS: HOLD COUNTER-BALANCE WEIGHTS IN POSITION WHEN KNIFE IS USED IN THE PLANER HEAD

FIG. B

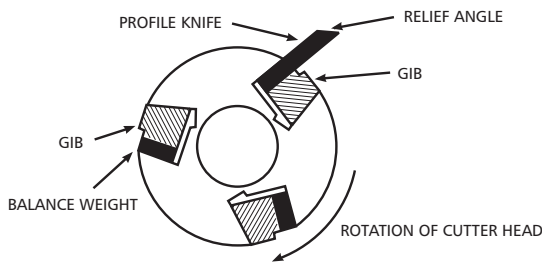

HOW TO INSTALL A SINGLE KNIFE IN THE 3-SLOT CUTTERHEAD

To maintain cutter head balance, use pattern knife with gib in one slot, use gib and one counter-weight in second and third slots.

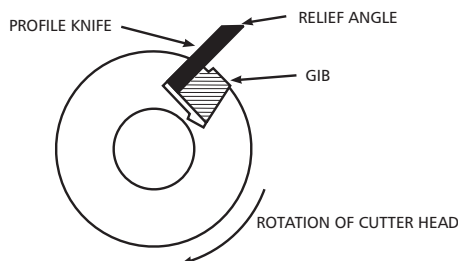

HOW TO INSTALL IN A SINGLE KNIFE HOLDER

To maintain shaft balance, use pattern knife and gib supplied with knife.

THE EASY WAY TO ORDER KNIVES

TOLL FREE ORDER LINE: 1-866-499-8399

FAX: 1-902-893-7890

EMAIL: sales@moldingknives.com

Choose from our selection of stock patterns found in this catalogue. Pay with Visa, MasterCard, American Express or PayPal. Over 90% of orders placed by noon Eastern Time are shipped the same day. *This includes custom knives!*

CUSTOM KNIVES: Email or Fax an accurate, full size drawing with the width and thickness measurements clearly marked, or send us an actual sample by Post (*please contact us before sending by any other method*). In most cases, custom knives are manufactured and shipped within one full business day from receipt of your order.

RUSH ORDERS: Next day delivery is available to most parts of the United States and Canada...Please order early in the morning to take advantage of this service.

PAYMENT: Payment may be made by Visa, MasterCard, American Express or PayPal.

QUESTIONS: We encourage you to call when placing an order. Our staff has experience with several brands of molders, as well as shapers, and we offer FREE advice and instruction sheets to our customers. Advice that may save you time and money.

Please check online for both updates and to view catalogues for knives that fit specific machines. <http://www.moldingknives.com>

MAIL ORDERS: Send your order to:

MOLDINGKNIVES.COM
1176 Black Rock Road
Clifton, N.S. B6L 1C1
Canada

TO ORDER

CALL TOLL FREE: 1-866-499-8399

PICTURE GLOSSARY

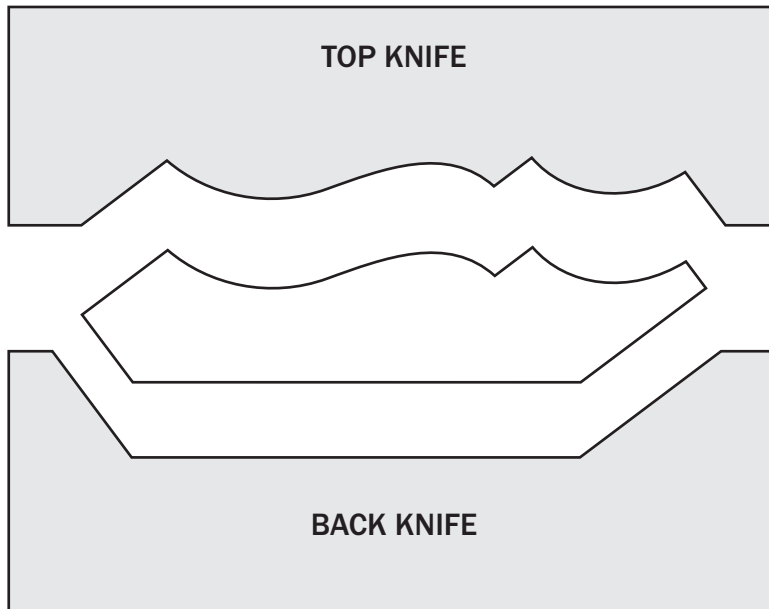
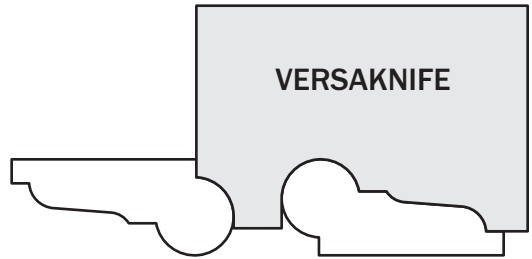
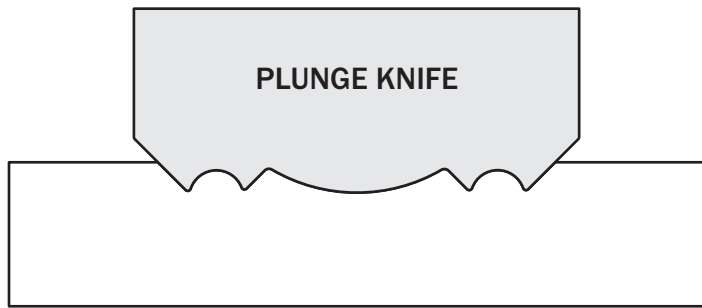
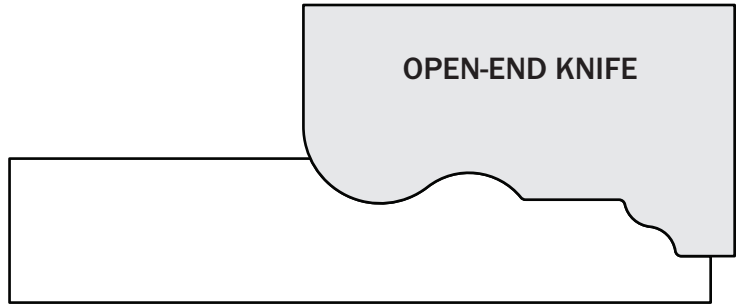
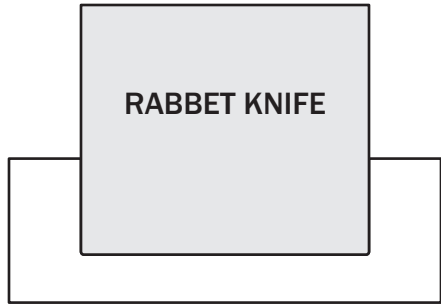

PICTURE GLOSSARY

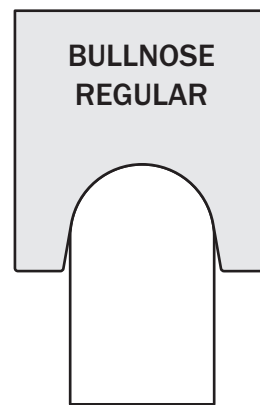
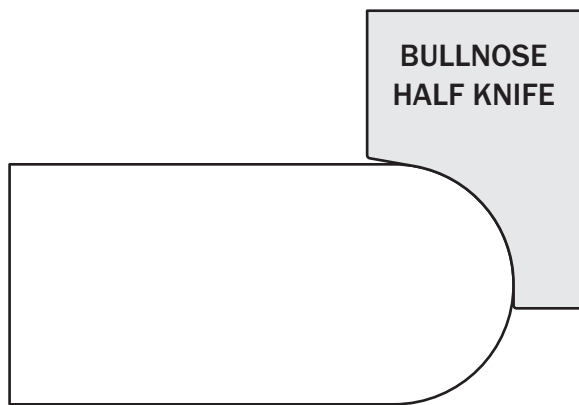
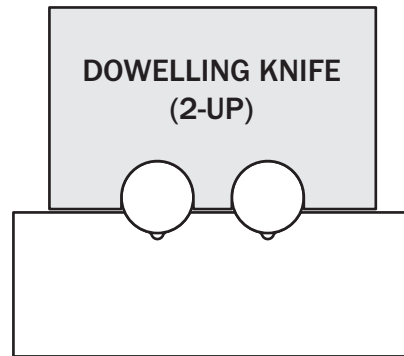
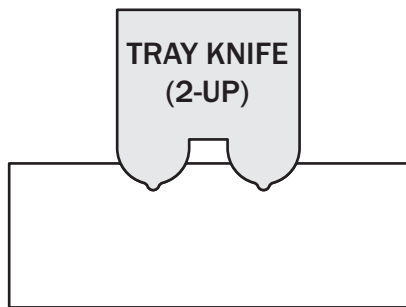
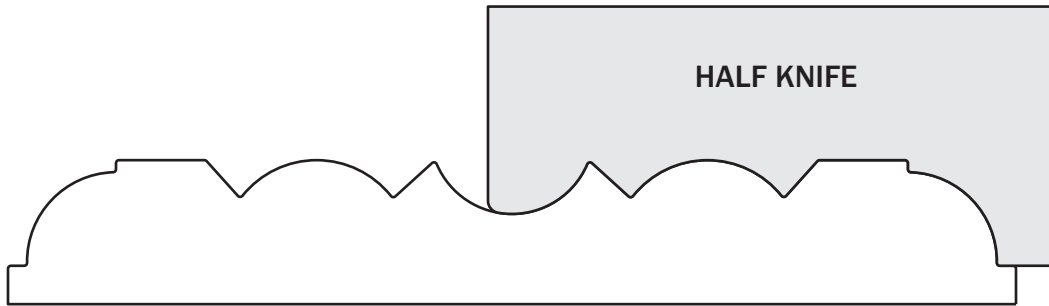
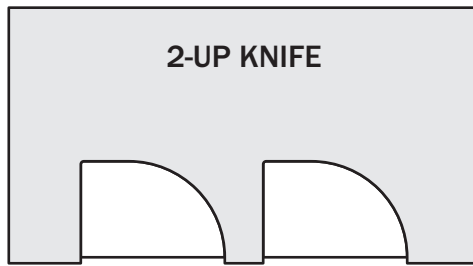

Bullnose Regular shows a vertically run board.

In addition to knives for all brands of molders and planer / molders, we also carry

Shaper Knives & Shaper Heads

2-7/8" diameter – two knife – 3/4" bore heads for corrugated knives (1/4" and 5/16" thick)

2" wide

3" wide

4" diameter – two knife – 1-1/4" bore heads for corrugated knives (1/4" and 5/16" thick)

2" wide

3" wide

4" wide

Adapters / Flange bushings

- WWB-0203/4" – 1/2"
- WWB-0301-1/4" – 3/4"
- WWB-0401-1/4" – 1"
- WWB-3175.301-1/4" - 30mm



We also carry European style shaper heads

Accepts knives that fit Baker 412, Logosol and Wood-Mizer planer moulder side heads, as well as some of the heads made by the following manufacturers: Amana, CMT and Freud.

Available in 3/4" bore and 1-1/4" bore.

Panel Cutter Head

Blades to fit our corrugated Panel Cutter Heads

- 3/4" bore headsCW - our best seller
CCW (special order)
- 1-1/4" boreCW or CCW

Sets of three (3) cutters available in M2 HSS or TCT Carbide.

Allows you to run your panels horizontally.

We also make blades to fit our regular corrugated shaper heads (vertical run), and most other brands of corrugated panel cutter heads and shapers.



Stock profiles - (See our website for a complete listing of our stock panel cutter head profiles).

Custom profiles made within one full business day upon your approval of our drawing.

Can't find an off the shelf router bit?

Our interchangeable
Router Bit Holder (RBH)
may be the solution.



What it does:

- quick turn-around and affordable solution
- for solid wood applications
- great for routers fixed in a table
- offers a wide variety of Tongue and Groove, Decking, and more to fit the Woodmaster Double Router Attachment

What it does NOT do:

- not for MDF and/or composites
- not intended for use in hand held router

Send us a drawing or rough sketch with dimensions of the profile of wood that you need to make. We will promptly send you a quote.

Symtec Lathe Cutterbits

for both duplicating and free hand cutting.



Table Saw Cutters

To fit Sears Craftsman Table Saw cutterheads and Corob Cutterhead systems. Knives are priced in one of the following three categories:

Standard Profiles (these are mass produced)

See our website for a complete listing of our stock tablesaw cutter profiles.

Beadboard Series

Custom Profiles

Discounts available on volume orders.

Need the cutterhead?

We sell the Corob head to fit these table saw cutters.



The head is available in two sizes:

MHK25 3-5/8" in diameter

0.35" thick and approximately 4-7/8" in diameter with knives installed.

Fits many 5/8" arbor table saws

MHK75 5.7" in diameter

0.35" thick and approximately 6.9" in diameter with knives installed.

Intended for table saws that do not crank up high enough to accommodate the smaller diameter MHK25

Each head has a 5/8" bore. Please inquire about other special bore sizes.

We also make knives to fit the Delta Table Saw Cutterhead

Sandpaper

Whether you already use a Velcro® and cloth-back paper system on your Drum Sander, or you are looking to convert to this affordable and easy to change system, we have the paper for you.

This system is ideal for Drum Sanders that have a steel drum without any slots in it.

We have sandpaper to fit all models of Woodmaster Drum Sanders, and at least some models of the following brands of Drum Sanders;

Craftex
General
Grizzly

We stock the following grits of quality paper at a reasonable price:

3" wide cloth-back sandpaper
6" wide cloth-back sandpaper

40 grit
60 grit
80 grit
100 grit
120 grit
150 grit
180 grit
220 grit



4" wide self-adhesive Velcro®

Cope & Stile

We make both corrugated and European system Cope & Stile knife sets to a tolerance of within 0.005".

Our interchangeable knives allow you speed and versatility at an affordable price on both stock and custom profiles!

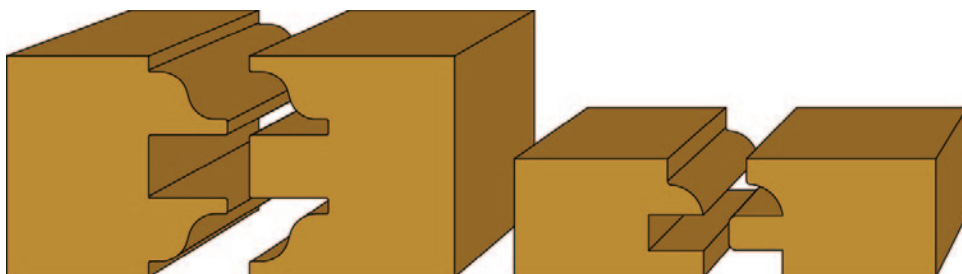

Dirose Professional Rosette Cutterbit System

The Rosette Cutterbit Head can be used in sturdy drill presses that will accept a 1/2" shank and you can use interchangeable bits (set of two bits per profile) in this head to make rosettes of your favorite design.

Rosette Cutterbit Head

Sets of two bits of your choice in:

1. Carbide (recommended for MDF and particle board)

stock profiles / custom profiles*

2. High Speed Steel (recommended for solid wood)

stock profiles / custom profiles*



Woodstock International Rosette Cutterbit Holder and blades

Try our one piece rosette cutter system!

Check out our stock rosette profiles online
www.moldingknives.com

***fax or email us your design**

Fax: 1-902-893-7890

Email: sales@moldingknives.com



We also make custom blades to fit the Grizzly cutter bit holder.
Contact us for pricing.

We carry a full range of
Planer Blades and Carbide Inserts



Check out our innovative bedboards



We make bedboards to fit most planer molders including:

- Shop Fox
- Williams and Hussey
- General International
- Grizzly
- Jet
- King
- Woodmaster
-and more!

The Mr. Smarty Bedboard does straight moldings, allowing you an economical and reliable way to cut into the top surface of the bedboard when required.

The Miss Smarty Bedboard is an economical and versatile bedboard for both curved and straight moldings with its strategically machined angles and pivots.



moldingknives.com

1176 Black Rock Road, Clifton, N.S. B6L 1C1

Tel: 1-866-499-8399 / Fax: 1-902-893-7890

***Current pricing and more items available online.
www.moldingknives.com***